

Agilent Technologies

U3047AM04

User's and Service Guide

Use this manual with the following documents:
PNA Series Network Analyzer On-line Help System



Manufacturing Part Number: U3047-90003

Printed in USA: April 2014

Supersede: March 2014

© Copyright 2014 Agilent Technologies, Inc. All rights reserved.

Warranty Statement

THE MATERIAL CONTAINED IN THIS DOCUMENT IS PROVIDED "AS IS," AND IS SUBJECT TO BEING CHANGED, WITHOUT NOTICE, IN FUTURE EDITIONS. FURTHER, TO THE MAXIMUM EXTENT PERMITTED BY APPLICABLE LAW, AGILENT DISCLAIMS ALL WARRANTIES, EITHER EXPRESS OR IMPLIED WITH REGARD TO THIS MANUAL AND ANY INFORMATION CONTAINED HEREIN, INCLUDING BUT NOT LIMITED TO THE IMPLIED WARRANTIES OF MERCHANTABILITY AND FITNESS FOR A PARTICULAR PURPOSE. AGILENT SHALL NOT BE LIABLE FOR ERRORS OR FOR INCIDENTAL OR CONSEQUENTIAL DAMAGES IN CONNECTION WITH THE FURNISHING, USE, OR PERFORMANCE OF THIS DOCUMENT OR ANY INFORMATION CONTAINED HEREIN. SHOULD AGILENT AND THE USER HAVE A SEPARATE WRITTEN AGREEMENT WITH WARRANTY TERMS COVERING THE MATERIAL IN THIS DOCUMENT THAT CONFLICT WITH THESE TERMS, THE WARRANTY TERMS IN THE SEPARATE AGREEMENT WILL CONTROL.

DFARS/Restricted Rights Notice

If software is for use in the performance of a U.S. Government prime contract or subcontract, Software is delivered and licensed as "Commercial computer software" as defined in DFAR 252.227-7014 (June 1995), or as a "commercial item" as defined in FAR 2.101(a) or as "Restricted computer software" as defined in FAR 52.227-19 (June 1987) or any equivalent agency regulation or contract clause. Use, duplication or disclosure of Software is subject to Agilent Technologies' standard commercial license terms, and non-DOD Departments and Agencies of the U.S. Government will receive no greater than Restricted Rights as defined in FAR 52.227-19(c)(1-2) (June 1987). U.S. Government users will receive no greater than Limited Rights as defined in FAR 52.227-14 (June 1987) or DFAR 252.227-7015 (b)(2) (November 1995), as applicable in any technical data.

Safety Notes

The following safety notes are used throughout this document. Familiarize yourself with each of these notes and its meaning before performing any of the procedures in this document.

WARNING **Warning denotes a hazard. It calls attention to a procedure which, if not correctly performed or adhered to, could result in injury or loss of life. Do not proceed beyond a warning note until the indicated conditions are fully understood and met.**

CAUTION Caution denotes a hazard. It calls attention to a procedure that, if not correctly performed or adhered to, could result in damage to or destruction of the instrument. Do not proceed beyond a caution sign until the indicated conditions are fully understood and met.

Definitions

- *Specifications* describe the performance of parameters covered by the product warranty (temperature –0 to 55 °C, unless otherwise noted.)
- *Typical* describes additional product performance information that is not covered by the product warranty. It is performance beyond specification that 80% of the units exhibit with a 95% confidence level over the temperature range 20 to 30 °C. Typical performance does not include measurement uncertainty.
- *Nominal* values indicate expected performance or describe product performance that is useful in the application of the product, but is not covered by the product warranty.
- *Characteristic Performance* describes performance parameter that the product is expected to meet before it leaves the factory, but is not verified in the field and is not covered by the product warranty. A characteristic includes the same guard bands as a specification.

Contents

U3047AM04

Introduction	2
Description	3
Verifying the Shipment	3
Network Analyzer Requirements	4
Available Options	5
Test Set Option	5
Rack Mounting Kits	5
Network Analyzer Interface Kit Options	5
General Specifications	6
Power Requirements	6
Environmental Requirements	7
Environmental Tests	7
Equipment Heating and Cooling	7
Required Conditions for Accuracy Enhanced Measurement	7
Dimensions and Space Requirements	7
Maximum Power Levels	8
Typical Reflection Tracking	9
Front and Rear Panel Features	10
Hardware Lock-link Installation (U3021-60002)	13
Locking the Test Set to the Network Analyzer	13
N5247A or N5227A RF Interface Cable Connections (U3021-60101)	16
Test Set I/O Cable Installation	17
Interconnect Cable Verification	17
System Operational Checks	18
Equipment Setup	18
Verify Results	18
Controlling the Test Set	21
Typeface Key Conventions	21
Sweep Setup for Multiport and Standalone PNA Modes	21
RF Path Configuration	22
Multiport Mode	23
How to Access Multiport Mode	23
External Test Set Control Operation	24
Selecting S-Parameter Measurement	25
Selecting New S-Parameter Measurement	25
N-Port Calibration	27
Interface Control Mode	29
How to Access Interface Control Mode	30
Using Interface Control Mode	31
GPIB Control Mode	33
Overview of the GPIB Control	33
How to Access GPIB Command Processor	34
GPIB Command Processor Console	35
Address and Data Values	36
Setting the Test Port Paths with Address and Data	36
Control Lines	38
Internal Voltage Supply Configuration	40
External Voltage Supply Configuration	41
Setting the Control Lines with Address and Data Values	42
Setting the Network Analyzer to Standalone Mode	42

Contents

Cal Kit Operational Check	44
Verification Limits	44
Equipment Required	45
Operational Check Procedure	45
Preparing the N5247A or N5227A	45
1-Port Calibration and Verification Procedure	46
Verifying Cal Kit Operational Check Failure	49
ECal Confidence Check	49
Service Information	51
Replaceable Parts	51
System Block Diagram	53
Theory of Operation	55
Test Set Control Board	55
Switch Interface Board	55
Front Panel LED Boards	55
DUT Control Board	55
Power Supply	55
RF Coupler	55
RF Switch Components	56
Source and Receiver Switch Paths	56
Troubleshooting the Test Set	57
Non-RF Failures	57
RF Switching Failures	60
Test Set RF Switching Path	61
Equipment Required	61
Equipment Setup	61
Cable Connections	62
Source Signal Path Insertion Loss Test	62
RF Performance Failures	65
Safety and Regulatory Information	68
Introduction	68
Safety Earth Ground	68
Declaration of Conformity	68
Statement of Compliance	68
Before Applying Power	69
Servicing	70
Connector Care and Cleaning Precautions	70
Electrostatic Discharge Protection	71
Regulatory Information	72
Instrument Markings	72
Battery Collection	73
Electrical Safety Compliance	73
EMI and EMC Compliance	73
Agilent Support, Services, and Assistance	74
Service and Support Options	74
Contacting Agilent	74
Shipping Your Product to Agilent for Service or Repair	74

U3047AM04

Introduction

This document describes how to use and service the U3047AM04 Multiport Test Set.

Figure 1 N5247A 4-Port with U3047AM04

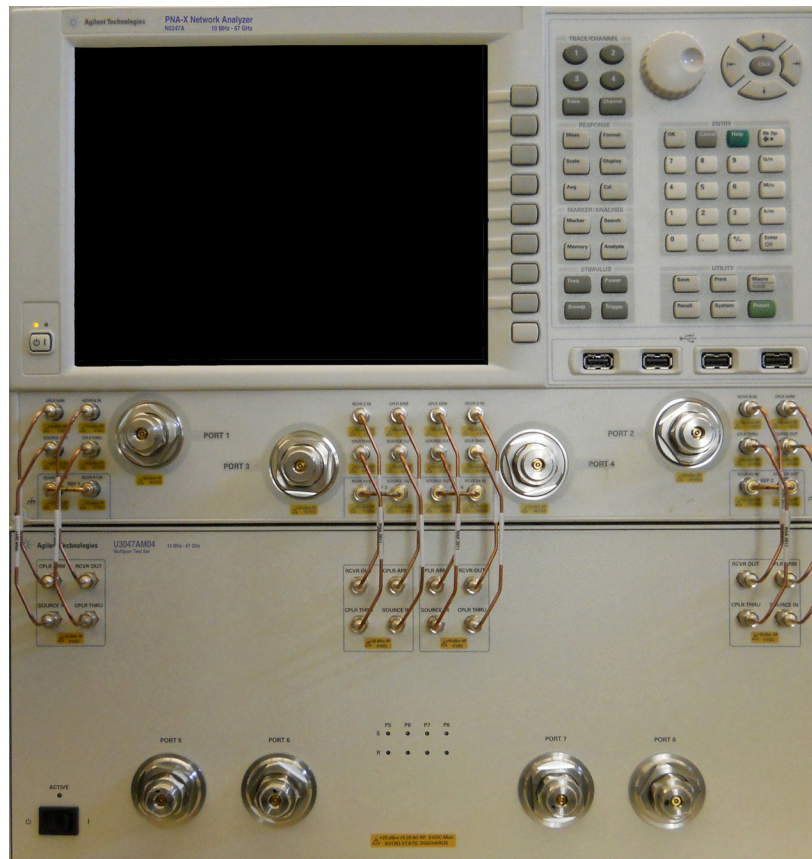

Description

The Agilent U3047AM04 is a Multiport Test Set that adds 4 ports to extend the 4-port network analyzer to 8 full crossbar test ports with N-Port calibration capability.

The Agilent U3047AM04 has the following key features:

- 4 test ports (1.85 mm male connectors)
- Low Loss Mechanical RF switching
- Frequency Range of Operation: 10 MHz - 67 GHz
- Test Set I/O interface for operational control with the network analyzer. Option 551 is required for N-port calibration. An external personal computer is not required.

The N5247A PNA-X and the N5227A PNA network analyzer will be referred to throughout this document as the analyzer. The U3047AM04 will be referred to as the test set.

Verifying the Shipment

To verify the contents shipped with your product, refer to the “Box Content List” included with the shipment.

Inspect the shipping container. If the container or packing material is damaged, it should be kept until the contents of the shipment have been checked mechanically and electrically. If there is physical damage refer to [“Contacting Agilent” on page 74](#). Keep the damaged shipping materials (if any) for inspection by the carrier and an Agilent Technologies representative.

Network Analyzer Requirements

All network analyzers require Option 551 for multiport operation (N-Port error correction and measurement capability). [Table 1](#) provides a listing of other network analyzer option requirements. The analyzer's frequency range must be equal to or exceed that of the test set so that the measurement system covers the full frequency range of the test set.

The test set files indicated in [Table 1](#) must be installed into the analyzer's file directory:
c:\Program Files\Agilent\Network Analyzer\testsets

Table 1 Network Analyzer Configuration Requirements

4-Port Network Analyzer	Options	Test Set File	System Figure
N5247A PNA-X or N5227A PNA	400, 551	u3047am04_pnax_p4.tsx	Figure 1 on page 2

Ensure that the network analyzer has the latest version of firmware installed. The following web site links provide the necessary information needed:

- Documentation - <http://www.agilent.com/find/pna>
- Network Analyzer Firmware - <http://na.tm.agilent.com/pna/firmware/firmware.htm>
- U3047AM04 Test Set Files - <http://na.tm.agilent.com/multiport> (see test set files)

Available Options

Test Set Option

Refer to [“System Block Diagram” on page 53](#).

- Standard - mechanical switches for low loss.

Rack Mounting Kits

Available options for system cabinet mounting:

- U3047AM04-1CP Rack Mount Kit with Handles (5063-9222)
- U3047AM04-1CM Rack Mount Kit without Handles (5063-9215)
- U3047AM04-1CN Front Handle Kit (5063-9228)

Network Analyzer Interface Kit Options

NOTE The U3047AM04 requires one of the following kits to interface the test set with your network analyzer. The interface kit model option includes the hardware lock-link and cable kit listed in [Table 2](#).

Table 2 Interface Kit Options

16-Port Network Analyzer System	Interface Kit Option	Hardware Lock-link	Cable Kit, Connector Type
N5247A PNA-X or N5227A PNA	U3021PX1 Opt 447	U3021-60002 ¹	U3021-60101 ² , 1.85 mm M/M

1. [“Hardware Lock-link Installation \(U3021-60002\)” on page 13](#).
2. [“N5247A or N5227A RF Interface Cable Connections \(U3021-60101\)” on page 16](#).

General Specifications

Specifications for the test set are characteristic for the system performance of the analyzer and the test set. Before using the analyzer and test set a calibration is recommended for best measurement performance. Actual performance of the system is based on the customer's analyzer and options that are used with the test set. A functional certificate is only offered for the test set.

When connected to a analyzer, this test set will degrade the performance at the test ports. The internal switch paths reduce test port power and power to the receivers. This affects the test port power of the analyzer and also reduces dynamic range. The reflection tracking values measured in the [“Cal Kit Operational Check” on page 44](#) can be subtracted from the analyzers dynamic range to determine the approximate performance of the system.

CAUTION The life expectancy of the following switches are 5 million cycles. When making measurements using more than one port, single sweeps are recommended to minimize switch cycles.

- N1811TL (x8, N1811-60019)
-

Power Requirements

Verify that the required ac power is available before installing the test set to the analyzer.

- 100/120/220/240 VAC (50/60Hz)
- The instruments can operate with mains supply voltage fluctuations up to $\pm 10\%$ of the nominal voltage.
- Air conditioning equipment (or other motor-operated equipment) should not be placed on the same ac line that powers the test set and analyzer.
- N5247A and N5227A maximum power is 450 W.
- U3047AM04 maximum power is 350 W.

WARNING This is a Safety Class I Product (provided with a protective earthing ground incorporated in the power cord). The mains plug shall be only be inserted in a socket outlet provided with a protective earth contact. Any interruption of the protective conductor inside or outside of the product is likely to make the product dangerous. Intentional interruption is prohibited.

Environmental Requirements

Refer to the PNA series standard documentation for environmental requirements.

Environmental Tests

The test set complies with all applicable safety and regulatory requirements for the intended location of use.

- Operating Environment (indoor use)
- Temperature 0 - 55 °C
- Pressure Altitude
3,000 meters (~10,000 feet)
- The instrument can safely operate in a relative humidity of 80% for temperatures to 31 degrees C, decreasing linearly to 50% relative humidity at 40 degrees C.

Equipment Heating and Cooling

If necessary, install air conditioning and heating to maintain the ambient temperature within the appropriate range.

CAUTION Ventilation Requirements: When installing the instrument in a cabinet, the convection into and out of the instrument must not be restricted. The ambient temperature (outside the cabinet) must be less than the maximum operating temperature of the instrument by 4 °C for every 100 watts dissipated in the cabinet. If the total power dissipated in the cabinet is greater than 800 watts, forced convection must be used.

Required Conditions for Accuracy Enhanced Measurement

Accuracy-enhanced (error-corrected) measurements require the ambient temperature of the analyzer and test set to be maintained within ± 1 °C of the ambient temperature at calibration.

Dimensions and Space Requirements

Standard installation of the test set and analyzer includes configuration and installation on a customer provided lab bench or table top of adequate size and strength. For weight, dimensions and space requirements, refer to the analyzer documentation that is used to configure the test set.

CAUTION The network analyzer is heavy. It is recommended that two individuals, or a mechanical lift be used to lift or transport the instrument.

Table 3 Instrument Dimensions

Model	Weight	Height	Width	Depth
U3047AM04	17.8 kg (22 lb)	17.8 cm (7 in)	43.1 cm (17 in)	50.8 cm (20 in)

Maximum Power Levels

CAUTION It is recommended that you do not operate components near damage levels (+28 dBm). The power levels must be 3 dB below maximum level to ensure no damage.

Table 4 Maximum Power Levels

U3047AM04 Test Port RF Power Levels:	
PORT 5-8	+25 dBm
U3047AM04 Access Ports:	
SOURCE OUT	+15 dBm
CPLR ARM	+15 dBm
CPLR THRU	+15 dBm
RCVR OUT	+15 dBm

NOTE Refer to your analyzer's specifications to determine the maximum input power levels for the access and test ports, or to optimize the power levels in the receivers.

NOTE Damage and maximum levels are not necessarily the optimum level.

Typical Reflection Tracking

Specifications for the reflection tracking are typical and are intended as non-warranted information.

NOTE Typical specifications are based on 1 to 2 units performance, see [Table 5](#).

Table 5 Typical Reflection Tracking

Frequency	Ports 1 to 4	Ports 5 to 8
10 MHz to 50 MHz	-0.5	-0.5
50 MHz to 200 MHz	-1	-1
200 MHz to 500 MHz	-1.5	-1.5
500 MHz to 3.2 GHz	-2.5	-2
3.2 GHz to 10 GHz	-4	-3
10 GHz to 13.5 GHz	-5	-3
13.5 GHz to 16 GHz	-5	-4
16 GHz to 20 GHz	-6	-4
20 GHz to 24 GHz	-6	-4
24 GHz to 26.5 GHz	-8	-5
26.5 GHz to 43.5 GHz	-9.5	-6
43.5 GHz to 46 GHz	-10	-6
46 GHz to 50 GHz	-11	-6
50 GHz to 67 GHz	-12	-7

Front and Rear Panel Features

Figure 2 U3047AM04 Front Panel

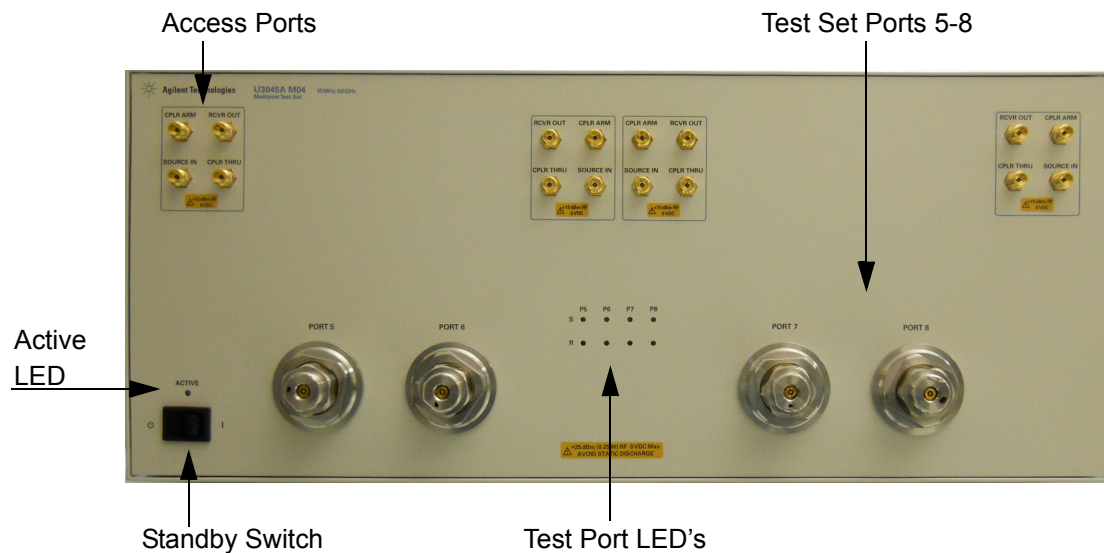

Test Ports – 1.85 mm Bulkhead (male)

- Port 5 – 8

Access Ports – 1.85 mm (female)

- RCVR OUT
- CPLR ARM
- CPRL THRU
- SOURCE IN

Test Port's LEDs

An illuminated LED indicates an active port in Source or Receiver mode. On the front panel “S” indicates Source test ports and “R” indicates Receiver test ports.

Standby Switch

Note that this switch is Standby only, not a line switch. The main power cord can be used as the system disconnecting device. It disconnects the mains circuits from the mains supply.

Active LED

The Active LED is On when the test set is connected and addressed by the analyzer. The LED is Off when the test set is in Standby, or not addressed by the analyzer.

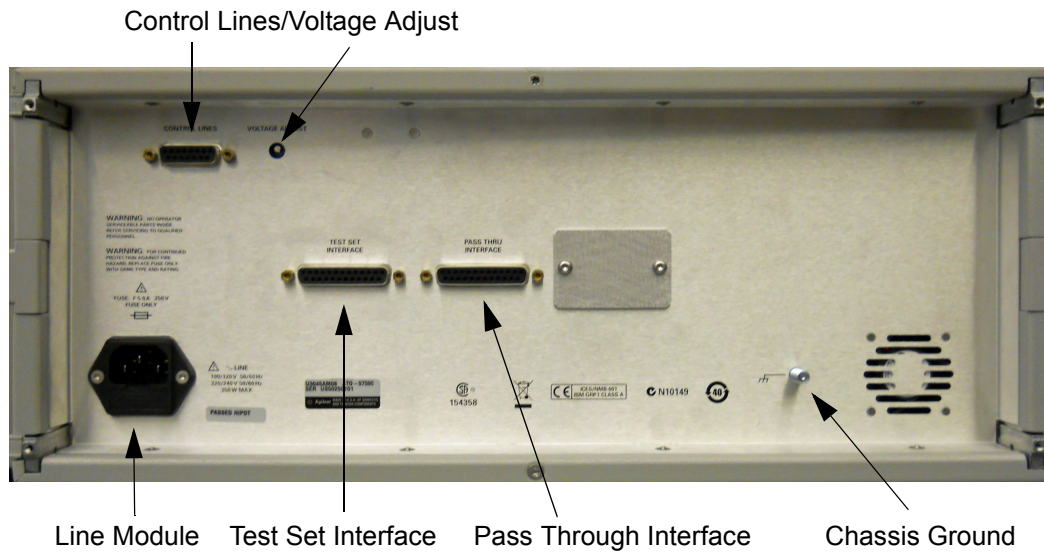
Figure 3 U3047AM04 Rear Panel

Control Lines and Voltage Adjust

For further information pertaining to control lines and voltage adjustments see [“Control Lines” on page 38](#).

Chassis Ground

A threaded terminal post for connecting the test set to a conductive object, cabinet or structure to ensure a common potential and reduce leakage current in a system. Requires an English 1/4-20 thread nut (2950-0004) and lock washer (2190-0067).

Pass Through Interface

The Pass Through Interface is used to connection to another test set.

Test Set Interface

The test set Interface connector is used to send address and data to the test set from the analyzer.

Power Cords

A line power cord is supplied in one of several configurations, depending on the destination of the original shipment. Agilent can supply additional certified power cords to meet region electrical supply and receptacle configurations. Please contact Agilent at: www.agilent.com for assistance in power cord selection.

WARNING The detachable power cord is the instrument disconnecting device. It disconnects the mains circuits from the mains supply before other parts of the instrument. The front panel switch is only a standby switch and is not a **LINE** switch (disconnecting device).

Line Module

The line fuse, as well as a spare, reside within the line module. [Figure 4](#) illustrates where the fuses are located and how to access them.

Install the instrument so that the detachable power cord is readily identifiable and is easily reached by the operator. The detachable power cord is the instrument disconnecting device. It disconnects the mains circuits from the mains supply before other parts of the instrument. The front panel switch is only a standby switch and is not a LINE switch. Alternatively, an externally installed switch or circuit breaker (which is readily identifiable and is easily reached by the operator) may be used as a disconnecting device.

CAUTION Always use the three-prong ac power cord supplied with this product. Failure to ensure adequate grounding by not using this cord may cause damage to the product.

Available Fuses

- Fuse (F 5 A/250V, 2110-0709) UL listed and CSA certified.
- Fuse (F 8 A/250V, 2110-0342) UL listed and CSA certified.

WARNING For continued protection against fire hazard, replace fuses, only with same type and ratings. The use of other fuses, circuit breakers or materials is prohibited.

Figure 4 Line Fuse



CAUTION Verify that the premise electrical voltage supply is within the range specified on the instrument.

Hardware Lock-link Installation (U3021-60002)

If your system is to be rack mounted, this installation procedure does not have to be performed.

WARNING **The opening of covers or removal of parts is likely to expose dangerous voltages. Disconnect the instrument from all voltage sources while it is being opened.**

Locking the Test Set to the Network Analyzer

1. The lock-link kit (U3021-60002) includes:
 - 5023-0132 - Lock-links kit (left, right pair and screws), analyzer
 - 0515-2317 - Screw T15 M3.5 x 0.6 12 mm
 - N5242-20138 - Right Lock-link, test set
 - N5242-20139 - Left Lock-link, test set
2. Remove the feet from the bottom of the analyzer.
3. Remove the 2 lower standoffs from the rear panel on the analyzer using a T20 torx driver.

Figure 5 **Rear and Bottom Feet**

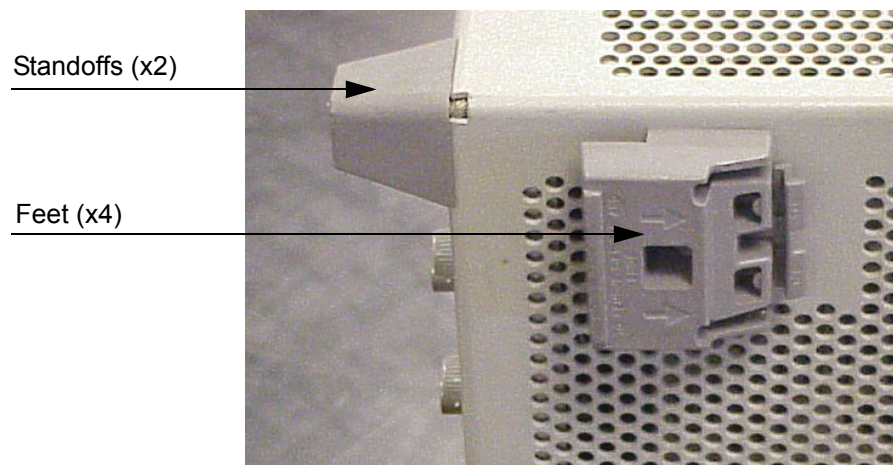

4. Install the lower left and right lock-links (left not shown) onto the analyzer.

Figure 6 Install Lock-links to the Network Analyzer

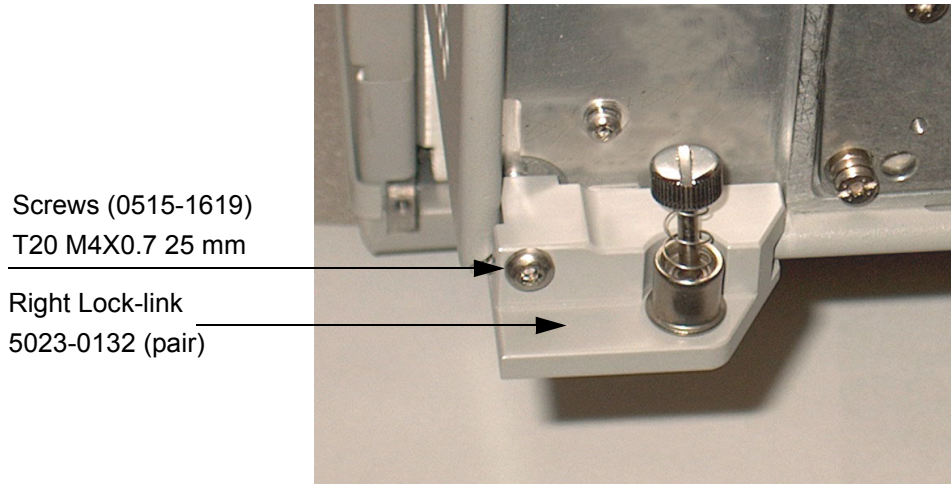

5. Remove the two upper standoffs from the rear panel of the test set using a T20 torx driver.
6. Install the left and right lock-links onto the test set.

Figure 7 Install Lock-links to the Test Set

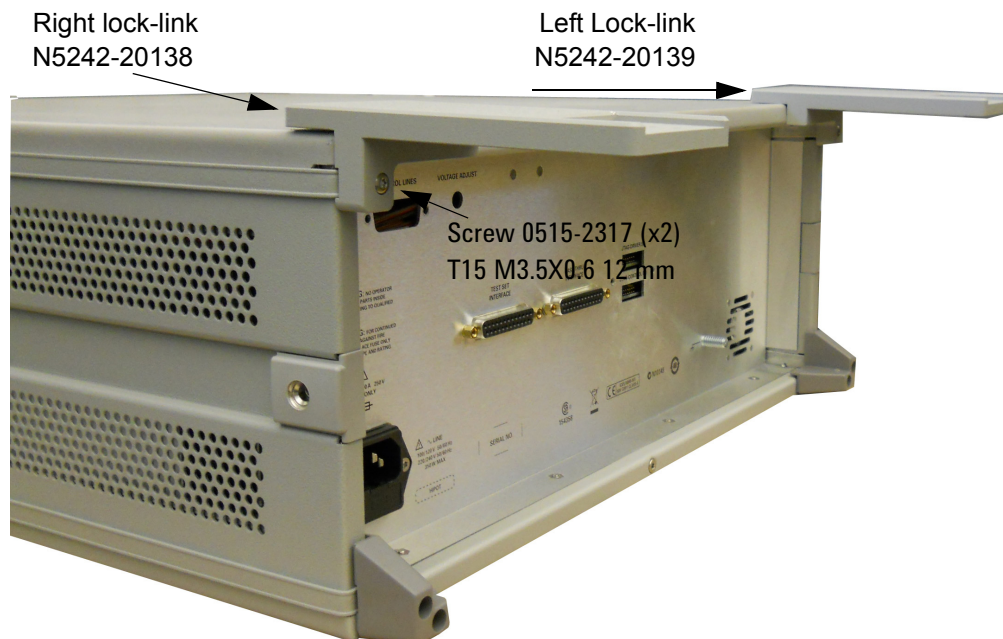

7. Place the analyzer on top of the test set and ensure that the front frame of the analyzer is positioned slightly forward of the locks that are attached to the test set. Slide the analyzer back so the locks engage the front frame of the analyzer.

Figure 8 Locking the Analyzer

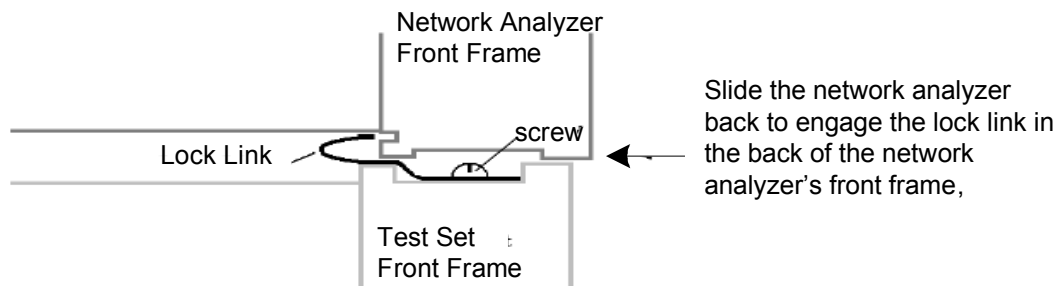

8. Secure the analyzer's lower lock-links to the test set's upper lock-link using the spring-loaded screws. If the analyzer's lock-links are not aligned with the screw holes, loosen the screws securing the feet to the instrument to align and tighten.

Figure 9 Locked

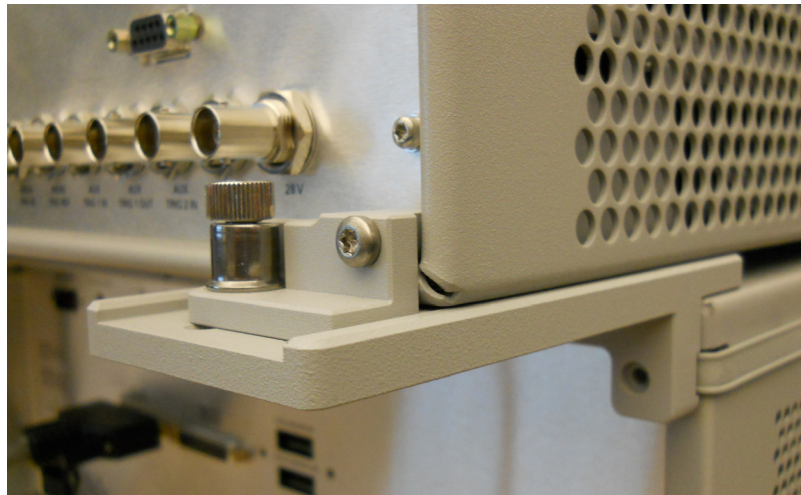

N5247A or N5227A RF Interface Cable Connections (U3021-60101)

Figure 10 illustrates the cable configuration of the test set to the analyzer. The cables have been supplied with Cable Kit (U3021-60101).

1. Remove the SOURCE OUT to CPLR THRU and RCVR IN to CPLR ARM jumpers (x8) on the analyzer. The RCVR R1 to SOURCE OUT reference loop jumpers (x4) remain on the front panel.
2. Connect the RF interconnect cables from the analyzer to the test set in the order listed. As you are connecting each cable, torque to 8 in-lb. Refer to Table 6 and Figure 10.

CAUTION Over torque will cause damage to the test set and may cause connectors to spin or become loose.

Table 6 RF Interface Cable Connection (U3021-60101)

Numeric Order	RF Cables	From: Network Analyzer	To: Test Set
1	U3047-20016	CPLR ARM	CPLR ARM
2	U3047-20016	RCVR IN	RCVR OUT
3	U3047-20017	CPLR THRU	CPLR THRU
4	U3047-20017	SOURCE OUT	SOURCE IN

Figure 10 illustrates the final two digits of the part number for each cable. The cables must be connected in the numeric order listed in Table 6.

Figure 10 8-Port Interface Connections



Test Set I/O Cable Installation

1. Connect the test set I/O cable (N4011-21002) to the test set Interface connector on the rear panels, similar to [Figure 11](#).

Figure 11 Test Set I/O Cable Connection



Interconnect Cable Verification

1. Perform the “[System Operational Checks](#)” on page 18.
2. If the problem still exists, perform the “[RF Switching Failures](#)” on page 60.
3. If a power hole or other failure still exists, refer to “[Contacting Agilent](#)” on page 74.

System Operational Checks

The following procedure will confirm that the RF interface cables between the test set and analyzer are installed and the system is working correctly. Ensure that your analyzer is calibrated by measuring the short on each port before connecting the test set.

Before beginning this procedure complete the following steps:

- Stack the analyzer on top of the test set.
- Install the test set I/O cable on the rear panel.
- Install all of the RF interface cables on the front panel.
- Install the included female 2.4 mm short (85056-60021) to analyzer Port 1.

Equipment Setup

- Turn On the test set and analyzer.
- Preset the analyzer and make the following settings:
 - Set to Multi-Port Mode
 - Frequency range: 10 MHz to 67 GHz
 - IFBW: 1 kHz
 - Scale: 10 dB/Div
 - Set the analyzer to measure S11

Verify Results

The 2.4 mm short will be relocated to each Test Port and an uncorrected reflection response trace should be displayed that resembles the following plots indicated in the table below. If you suspect an RF signal path problem, refer to the RF cable diagram and check the interface cables associated with this signal path for proper installation.

Table 7 Reflection Response Results

Reflection Port	Response Trace	Cable Path Diagram
Port 1 to 4	Figure 12 on page 19	Figure 13 on page 19
Ports 5 to 8	Figure 14 on page 20	Figure 15 on page 20

NOTE The trace ripple (peak-peak variation) will be higher than when using an ECal Module due to variation in your Short's performance. If response is in question perform [“Cal Kit Operational Check”](#) on page 44.

Figure 12 Typical Reflection Response Ports 1 to 4

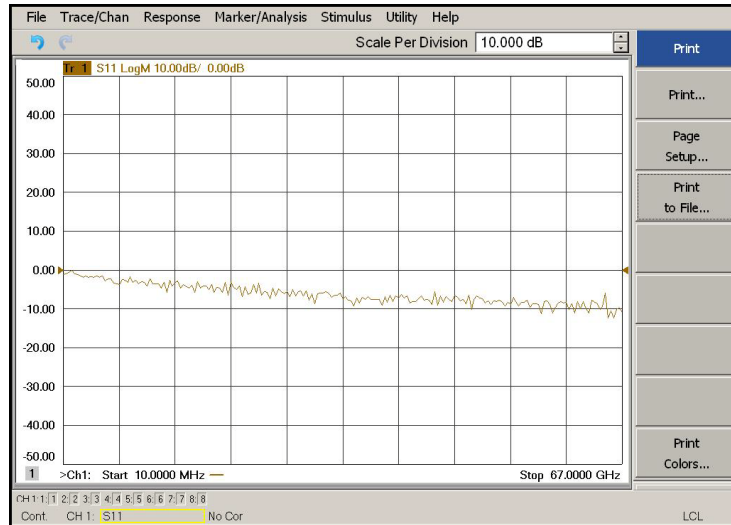

Figure 13 Reflection Response Signal Path Diagram Ports 1 to 4

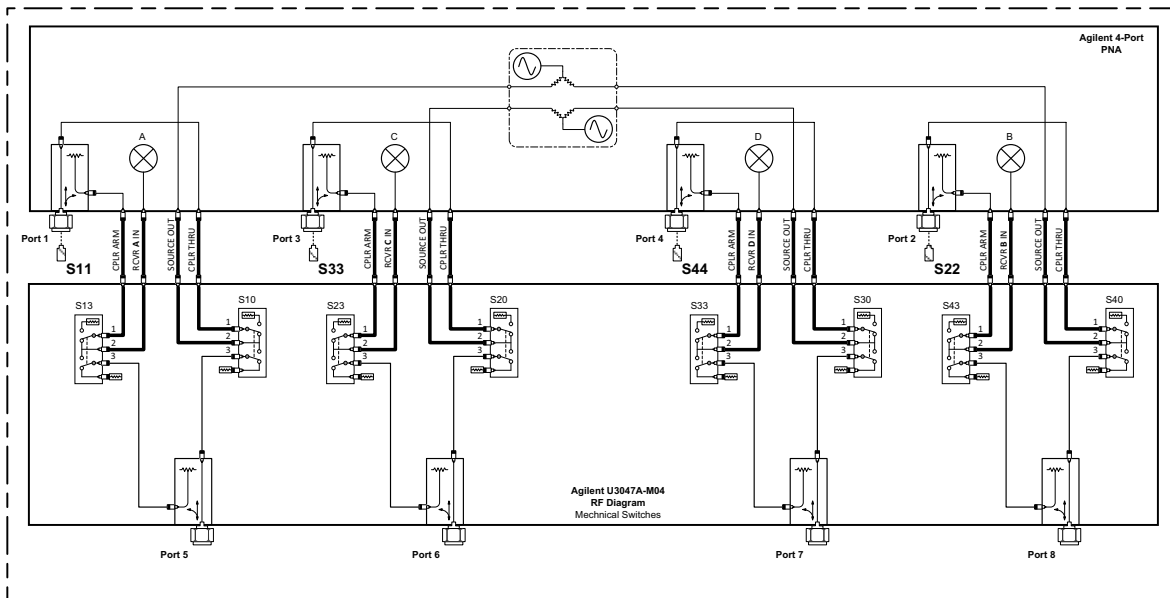

Figure 14 Typical Reflection Response Ports 5 to 8

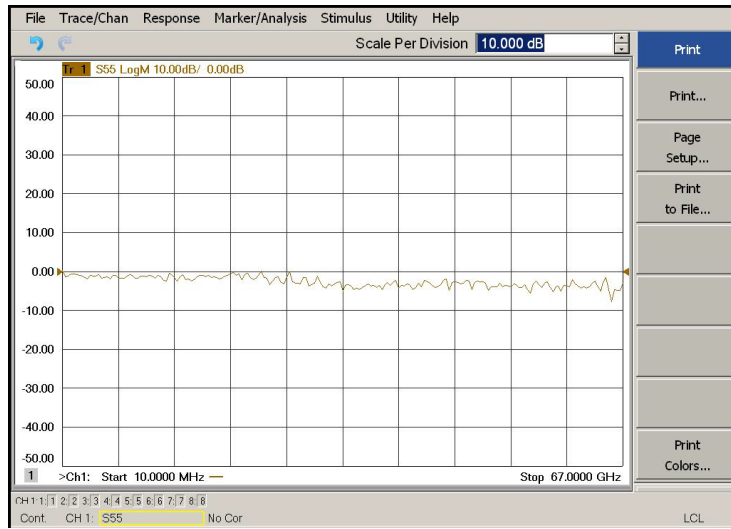
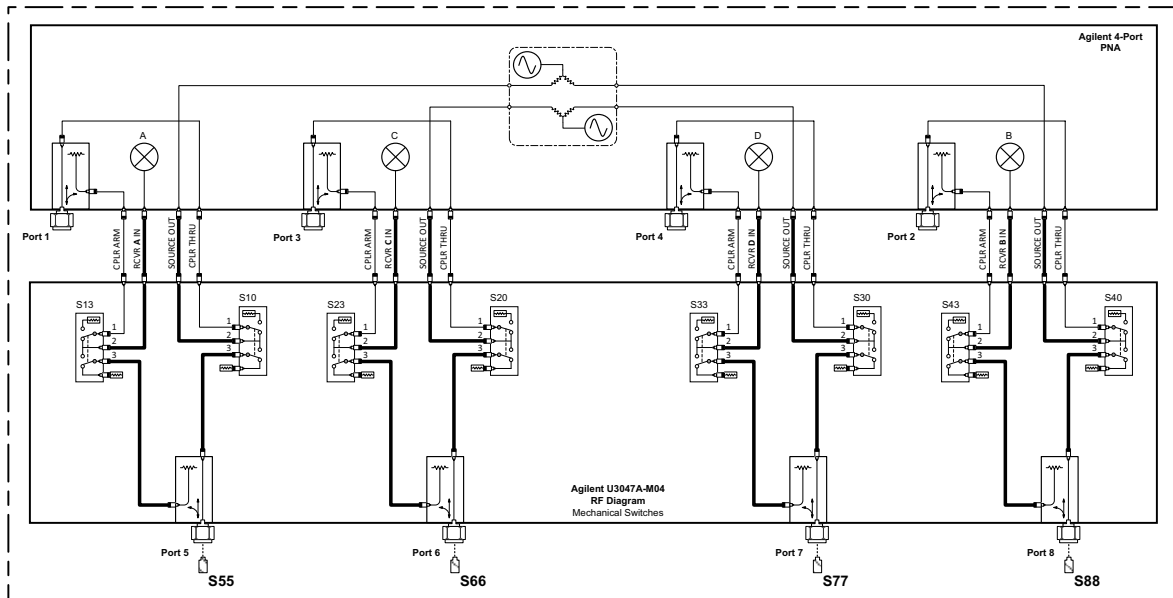

Figure 15 Reflection Response Signal Path Diagram Ports 5 to 8



Controlling the Test Set

This section will describe how to operate the test set with the analyzer.

The test set is considered a “slave” instrument. A network analyzer must be used to control the test set. There are three methods to control the test set. Multiport mode is recommended due to ease of use, and multiport calibration capability (N-Port).

- “Multiport Mode” on page 23
- “Interface Control Mode” on page 29
- “GPIB Control Mode” on page 33

Typeface Key Conventions

The following key conventions are used throughout this document.

- **[HARDKEYS]** are labeled front panel keys
- **SOFTKEYS** are indicated on the instrument display

Sweep Setup for Multiport and Standalone PNA Modes

Due to the extra electrical length of the test set and test port cables, it is recommended that the analyzer’s Sweep Setup be configured to Stepped Sweep before calibrating. This is slower than the Analog Sweep, but is more accurate. Stepped Sweep is available on all PNA models.

1. On the analyzer select **STIMULAS > Sweep > Sweep Setup**.
2. Select **Stepped Sweep**.
3. Set the **Dwell Time** to **5 ms > OK**.

Figure 16 Sweep Setup

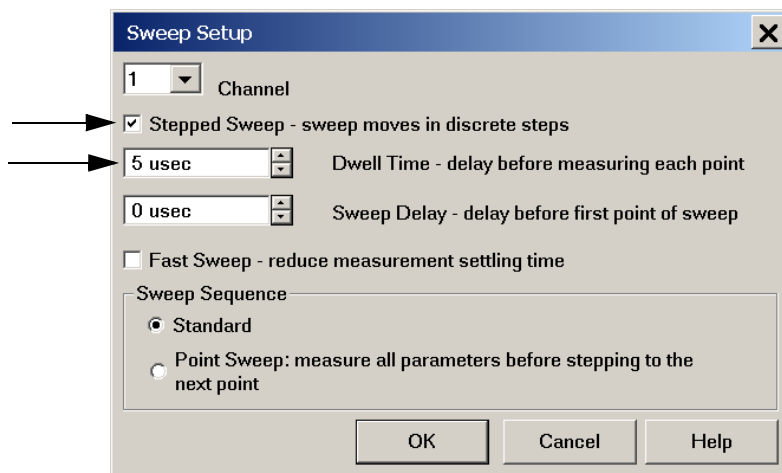

RF Path Configuration

NOTE If the analyzer has Option 029 or H29 (noise figure capability) verify that the path configuration is set to Default. If the network analyzer is not in Default configuration, ports 5 and 9 will not operate correctly. Select **Trace/Chan > Channel > Hardware Setup > Path Cong...** and in the drop-down menu select **Default > OK**. Save this configuration as a User Preset by selecting **Save > User Preset > Save current state as User Preset**. Do not use the factory Preset (User Preset Off), the analyzer will return to Option 029 path configuration.

Figure 17 RF Path Configuration

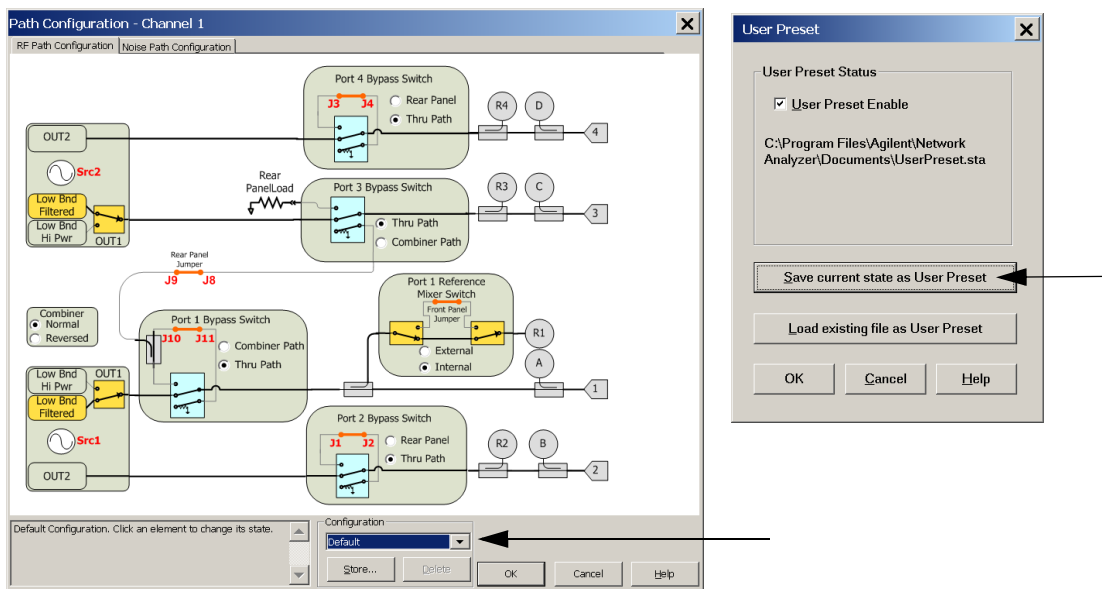

Multiport Mode

The multiport mode selects the test set file that will enable the analyzer to control the test set. Multiport mode allows you to complete a N-Port calibration using the Cal Wizard application in the analyzer. Refer to the Help system for more information.

How to Access Multiport Mode

1. The Option 551 must be installed for multiport capability. To access the multiport application select **Utility > System > Configure > Multiport Capability**.
2. Select **U3047AM04_PNAX_p4** (8-Port System) from the drop-down menu and select **Restart as a multiport PNA with this testset > OK**.

If the test set is not available in the drop-down list, it will be necessary for you to copy the required test set file to the analyzer's hard drive. The current version of the test set files are available on the web at <http://na.tm.agilent.com/multiport>. Copy the appropriate file to c:\program files\Agilent\Network Analyzer\testsets directory.

Figure 18 Test Set Selection

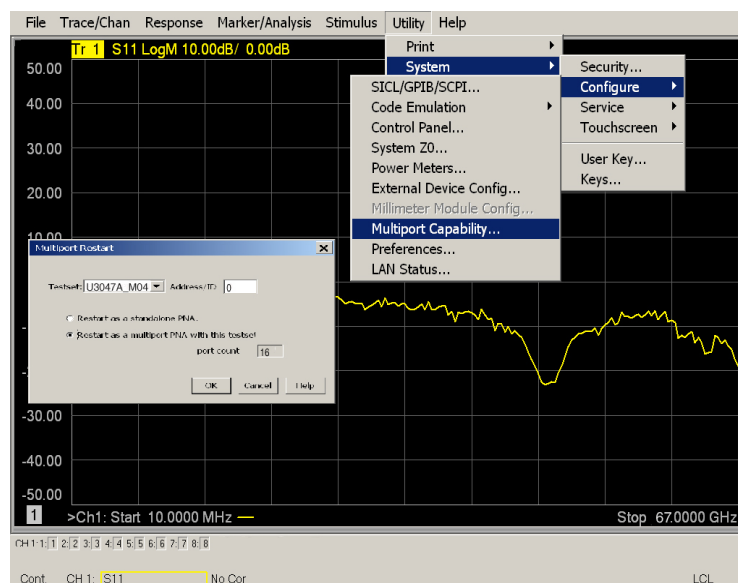

External Test Set Control Operation

To verify that the network application has the test set interface features, select **Trace/Chan > Channel > Hardware Setup > External Test Set > Other**. The test set will be displayed as **External Test Set Control-U3047AM04**.

Figure 19 External Test Set Control

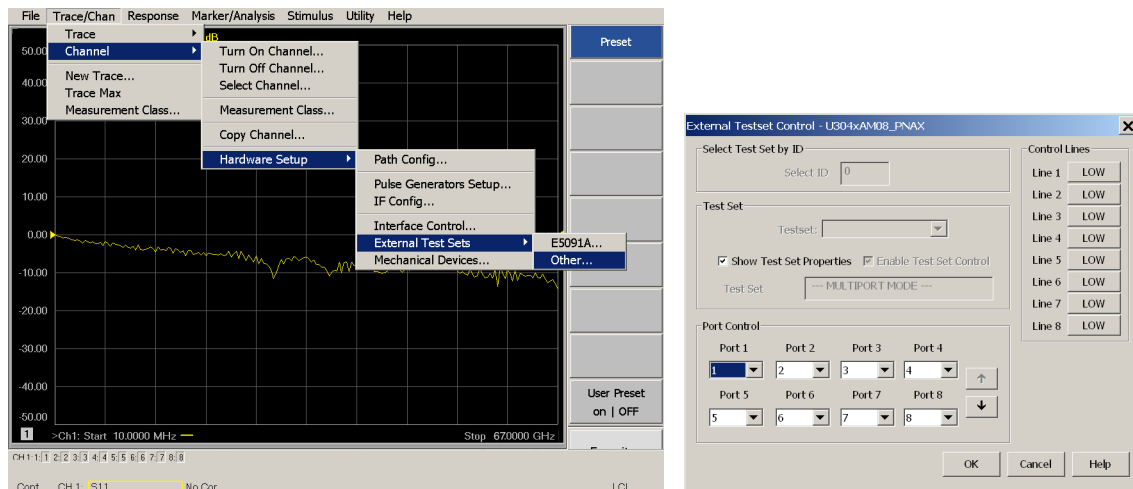

This menu will allow the physical Ports 1 thru to be identified as any port for your convenience. For example; Port 5 can be re-named Port 2.

The **External Test Set Control-U3047AM04** also allows control of the DUT control lines, refer to [“Control Lines” on page 38](#). To change the state from LOW to HIGH, select the graphical user interface (GUI) for the specific control (LINE 1 to 8), click **OK**. Each line can be controlled separately.

Selecting S-Parameter Measurement

S-Parameter selection can be accomplished using **Response > Measure**. Use the drop-down menu to select 1 of 256 S-Parameters for the 8-Port system. The first number in the Sxx selection is the Receiver Port and the second number will be the Source Port. Any port can be selected to be the Receiver, Source or both, as in S11. The front panel R LED indicates the port is the Receiver and the S LED indicates the port is the Source.

Figure 20 S-Parameter Measurement

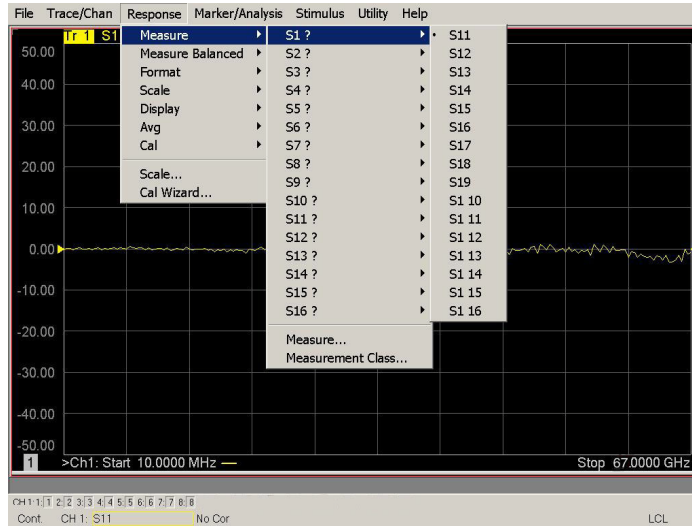

Selecting New S-Parameter Measurement

S-Parameter Tab: Multiple S-Parameters can be made from the **New Trace** menu. In the drop-down menu select **Trace/Chan > Trace > New Trace**. The dialog box allows the selection of any of the 144 S-Parameter's.

Figure 21 New S-Parameter Measurement

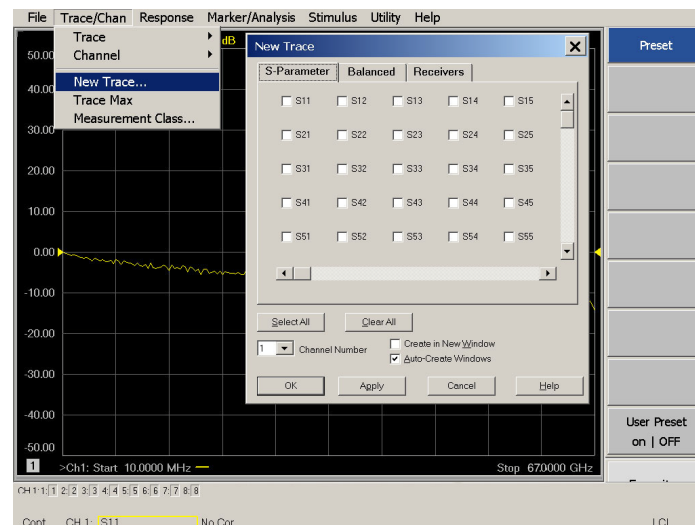

Balanced Tab

Balanced Measurements can be configured by selecting the Balance tab in the New Trace menu.

For more information on balanced (differential) component measurement, refer to the Application Note 1373-1 and 1373-2 (5988-5634EN and 5988-5635EN) at <http://www.home.agilent.com>. In the search menu type “Multiport and Balanced.”

Figure 22 Selecting Balanced Measurements

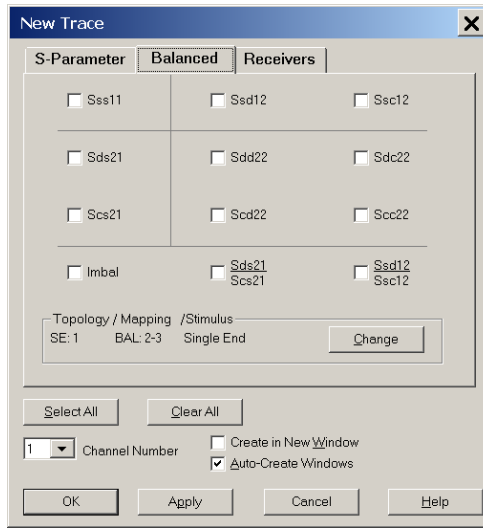

Receivers Tab

The S-Parameter measurements can be ratioed with selectable Denominators for each port and receiver. Refer to the standard analyzer documentation for more information.

Figure 23 Receiver Measurements

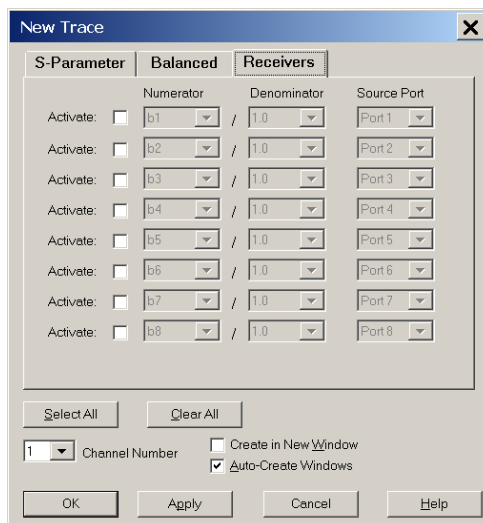

N-Port Calibration

It is recommended that you perform an ECal characterization to minimize the connections required for multiple port calibration. The N4694A/B Option M0F is recommended with cable (85133F) if you are calibrating directly on the analyzer and test set ports.

Characterize the ECal module with adapters that will not be used in the measurement of the DUT. To characterize the ECal module select **Response > Cal > More > ECal > Characterize ECal Module**.

Calibrate at the end of the test port RF cables and any adapters that are used to connect the DUT. This removes the effect on the measurement of the DUT. Failure to do this will create ripple and other measurement errors.

NOTE If measurement errors occur, ensure the newest version of firmware is installed on the analyzer. Measurement errors can be a result of firmware algorithms. Consult with Agilent Service or firmware web page for the latest Option 551 firmware revisions and history.
<http://na.tm.agilent.com/pna/firmware/firmware.htm>

Figure 24 ECal Characterization

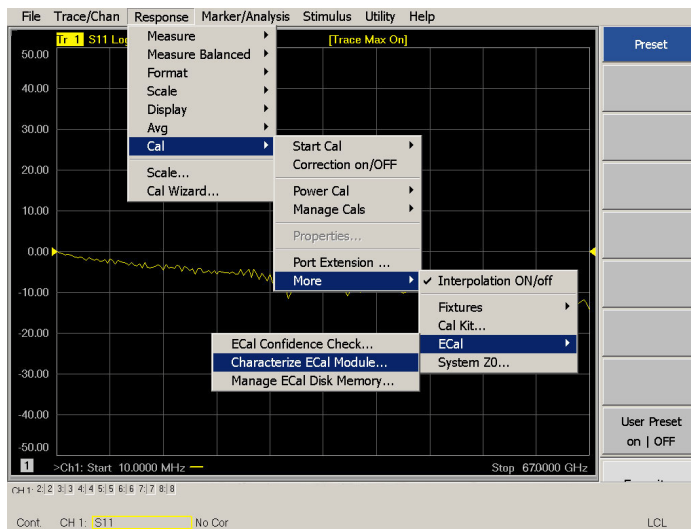

1. On the analyzer select **Response > Cal Wizard**.
 - a. If using a mechanical cal kit, select **SmartCal (Guided Calibration) > Next**.
 - b. If using an ECal module, connect the ECal to an available USB port on the analyzer and select **Use Electronic Calibration (ECal) > Next**.

Figure 25 Begin Calibration

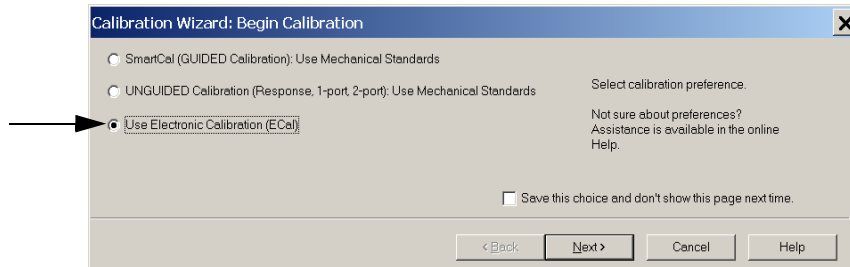

2. Continue following the Cal Wizard prompts. In the Select Calibration Ports and ECal Module dialog box click the **Select All**, check box, or select the ports you are calibrating and click **Next**. If an ECal characterization has been done, select **View/Select ECal Module** and select the previously saved user file from [step 1](#).

Figure 26 8-Port Calibration

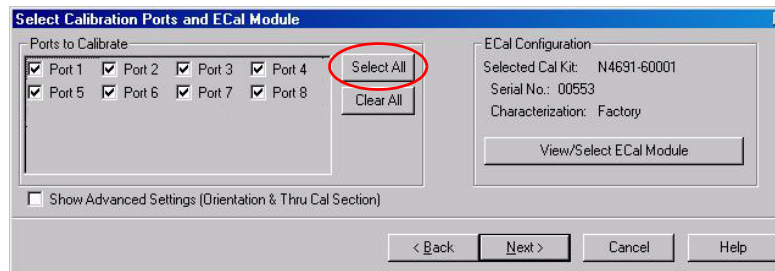

3. Connect the ECal or the mechanical cal kit to the ports you are calibrating following the Cal Wizard prompts and click **Measure** after each connection. The electrical delay value may be shown in the dialog box after the last measurement, click **OK**.
4. At the Calibration Completed prompt, select **Save As User Calset**, type the name and **Save**. See [Figure 36 on page 46](#).
5. After calibrating test set ports, use a quality load and short to verify the calibration on each port or end of the test cable. Measure reflection and confirm the return loss is as expected. If the result is not as expected, repeat the calibration without the test set and ensure that the analyzer is in standard (non-multiport) mode.

NOTE If measurement errors occur, ensure the newest version of firmware is installed on the analyzer. Measurement errors can be a result of firmware algorithms. Consult with Agilent Service or firmware web page for the latest Option 551 firmware revisions and history.
<http://na.tm.agilent.com/pna/firmware/firmware.htm>

Interface Control Mode

The Interface Control feature allows you to send data and remote commands to control external equipment using the GPIB, Material Handler I/O, Test Set I/O, and Auxiliary I/O without the need of an external computer. Refer to analyzer's Help menu, "Rear Panel Tour" and "Interface Control."

This section includes:

- How to Access Interface Control Settings
- Interface Control dialog box

NOTE The interface control mode will not function properly when using multipoint mode. The multipoint mode will reset the switch path commands of the interface control. It is recommended that the analyzer be restarted in stand-alone mode if the interface control is being used.

- A unique set of control data can be sent for each channel. In addition, a unique set of control data can be sent before the channel sweep starts and after the sweep ends.
- Interface Control settings can be saved and recalled from the Interface Control dialog box or with Instrument State Save and Recall.
- Interface Control settings can be copied to other channels using Copy Channels.
- Control data can only be WRITTEN to the interfaces, NOT READ from the interfaces.
- Control data is sent in the following order and this order cannot be changed:
Refer to the Help menu.
 1. GPIB Interface
 2. Material Handler Interface
 3. Test Set Interface
 4. Dwell Time

How to Access Interface Control Mode

1. To access the Interface Control mode, select **Trace/Chan > Channel > Hardware Setup > Interface Control** in the drop-down menu, and select **Enable Interface Control**.

NOTE The PNA or PNA-X Series Network Analyzer include the Interface Control application and rear panel connection. Please review this application before connecting the test set to the analyzer. Information regarding this application can be found in the analyzer's Help menu, Interface Control. The application is shown below.

Figure 27 Interface Control Mode Selection

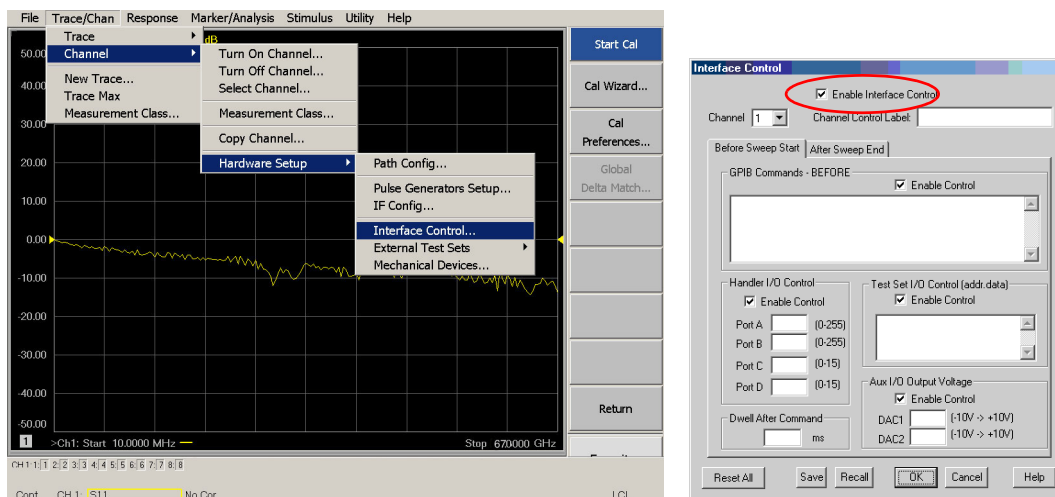

Using Interface Control Mode

An Instrument Preset will reset all of the fields to their default settings.

NOTE If an error is encountered when sending Interface Control data, an error message is shown on the analyzer's display and the Channel Trigger State is set to Hold. You must fix the condition that caused the error, then change the Channel Trigger State to its original setting.

Figure 28 Interface Control

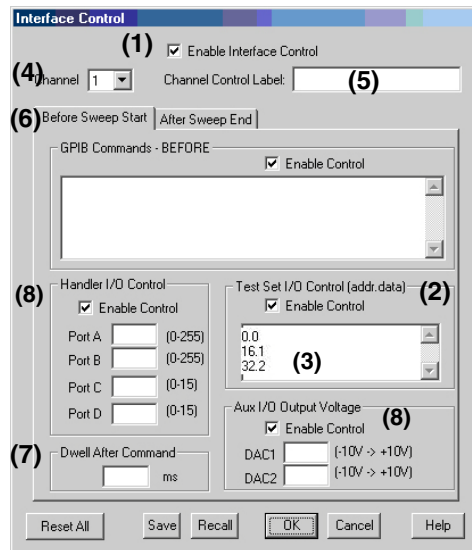

Enable Interface Control: (1)

Enables and disables ALL Interface Control communication. When cleared (default setting) Interface Control is disabled and NO data is sent. To send data, the individual interfaces must also be enabled.

Test Set I/O Control (addr.data): (2)

Provides control of the test set I/O Interface on the rear panel of the analyzer. Used to control your test set.

Only positive integers are allowed to select switch positions or states of DUT control interface lines. Refer to [“Address and Data Values” on page 36](#).

Address and data integers must be separated by a period. Each set of entries should be separated by a new line, or carriage return. The front panel Enter key can be used to insert a new line into the field. The quantity of test set I/O entries that can be entered is limited by the available memory of the analyzer.

Address and Data example: **addr.data (3)**

0.0

16.1

32.2

Channel: (4)

Specifies the channel number for dialog settings. Each channel is configured individually. The drop-down list illustrates the channels that currently have measurements. There must be at least one displayed trace for the test set I/O Interface to function.

Channel Control Label: (5)

Specifies the label to be shown on the analyzer's display during the channel sweep.

Before Sweep Start – After Sweep End Tabs: (6)

Commands (GPIB, I/O's and Dwell) can be sent Before Sweep Start and After Sweep End. However, they are configured and enabled separately on the Interface Control dialog box. For example; to send a command before and after a analyzer sweep, the Enable Interface Control check box must be selected and commands entered in both the Before Sweep Start and After Sweep End tabs. The **Before Sweep Start** data is sent before the first trace on the channel begins sweeping. The **After Sweep Start** data is sent after the last trace on the channel sweep is completed.

Dwell After Command: (7)

Specifies a wait time, in milliseconds, after all commands to all interfaces are sent. Any positive integer is allowed. This is used to allow all external devices to settle before beginning a measurement. An erratic trace could indicate that more settling time is necessary.

Handler I/O Control and Aux I/O Output Voltage: (8)

Provides I/O interface control through the rear panel of the analyzer. Refer to the analyzer's Help menu for further information.

Reset All:

Sets all fields on all channels to their default values.

Save and Recall:

Saves and recalls the contents of the dialog box. If the Interface Control dialog box is populated with settings during an Instrument State Save, the settings are automatically recalled with the instrument state settings. Interface control uses an *.xml file type. An example file is stored on the analyzer's hard drive. You can recall it into the dialog, or you can open and edit it with a word processor, such as Word Pad.

OK:

Applies the settings and closes the dialog box.

Cancel:

Does not apply changes that were made and closes the dialog box.

Help:

Provides additional information for using the interface control application.

GPIB Control Mode

The PNA or PNA-X GPIB Command Processor feature allows you to send remote commands and data to the analyzer's rear-panel GPIB connector and test set I/O connector. More information regarding the GPIB Command Processor can be found in the analyzer's Help menu.

- Overview
- How to Access GPIB Command Processor
- GPIB Command Processor Console

Overview of the GPIB Control

The GPIB Command Processor allows you to send address and data to control an external test set, without needing to create a remote program. The user is required to manually input address and data using the GPIB Command Processor Console in the analyzer's Help menu.

- GPIB Command Processor settings can not be saved or recalled.
- Address and data can be *written* from the GPIB Command Processor.

How to Access GPIB Command Processor

1. To access the GPIB Command Processor select **Utility > System > Configure > SICL/GPIB/SCPI**.

Figure 29 Utility Configure

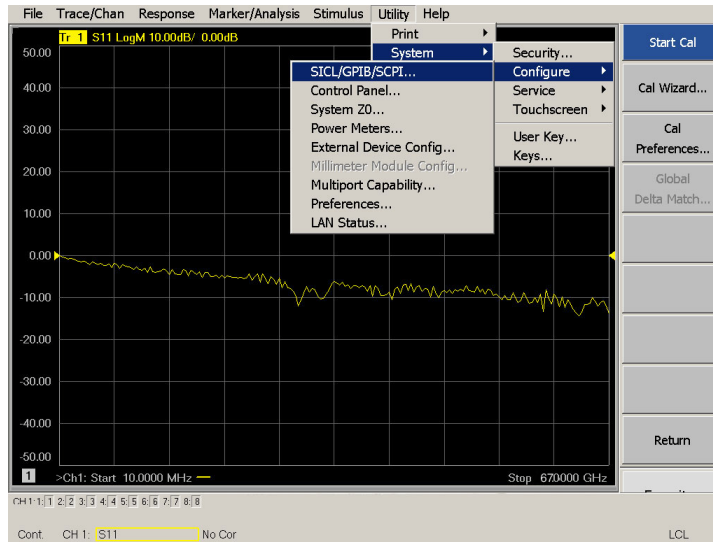

2. Select **GPIB Command Processor Console > OK**.

Figure 30 GPIB Command Processor

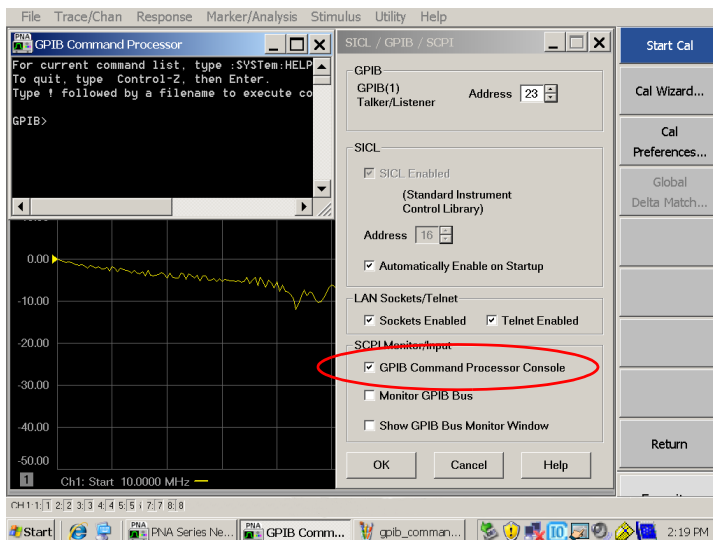

GPIB Command Processor Console

Write Commands Once the GPIB Command Processor Console is open, commands can remotely control the external test set I/O connector by sending the following:

address: a integer number

data: a integer number

Address and data are separated by a comma. Commands should be separated by a new line, or carriage return.

For example:

```
CONT:EXT:TEST:DATA <address>,<data>
```

```
CONT:EXT:TEST:DATA 0,0
```

Example: CONT:EXT:TEST:DATA 0,0

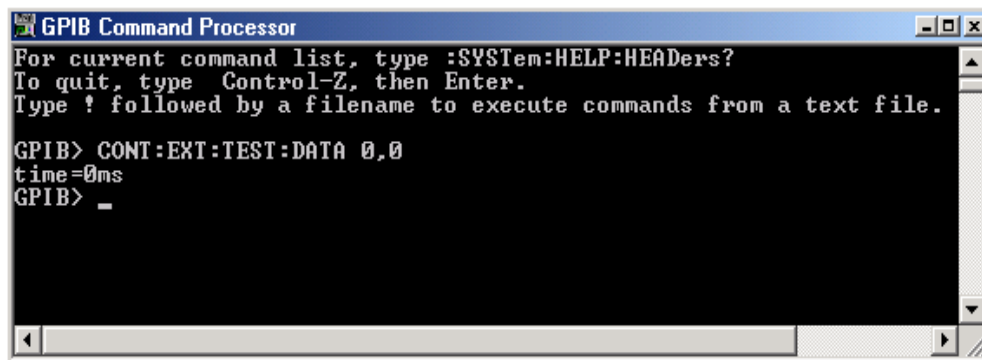

```
GPIB Command Processor
For current command list, type :SYSTEM:HELP:HEADers?
To quit, type Control-Z, then Enter.
Type ! followed by a filename to execute commands from a text file.

GPIB> CONT:EXT:TEST:DATA 0,0
time=0ms
GPIB> _
```

Refer to [“Address and Data Values”](#) on page 36.

Address and Data Values

Setting the Test Port Paths with Address and Data

Refer to [Table 8](#) and [Figure 31 on page 37](#) for information to set the internal switch paths of the test set.

The address is the first value in the test set I/O control or GPIB data command. The second value controls the source and receiver paths of the ports. To select a test set port configuration both switches must be set to complete the source and receiver paths. To do this you must add the data values together to determine the data command value for each port, which is the second number in the test set I/O or GPIB command.

Example 1: Refer to [Figure 31 on page 37](#).

If the ports have different addresses, two separate address data commands must be used.

Port 5 is the Source and Port 6 is the Receiver.

Source Port 5 = address 0, data 1 and Receiver Port 6 = address 16, data 16.

Two separate commands must be sent, you may use the same dialog box. Send address 0 and data 1 in one command line, and address 16 and data 16 in the second line. Refer to [“Interface Control Mode” on page 29](#) and in [“GPIB Control Mode” on page 33](#).

For further information refer to [“How to Access Interface Control Mode” on page 30](#) and [“How to Access GPIB Command Processor” on page 34](#).

Example 2:

If the ports have the same address, only one command is needed.

Port 1 is the Source and Ports 5 is the Receiver.

Source Port 1 = address 0, data 0 and Receiver Port 5 = address 0, data 16. The data values are added together, the entry will be 0.16.

Table 8 Test Port Address and Data Values

Address	Data	Source Path		Receiver Path	
		0	1	0	16
0	Ports	1	5	1	5
16	Ports	3	6	3	6
32	Ports	4	7	4	7
64	Ports	2	8	2	8

Refer to [Figure 42, “RF Block Diagram,” on page 53](#) for in-depth RF path information.

Figure 31 Address and Data Example 1 (Port 5 and 6)

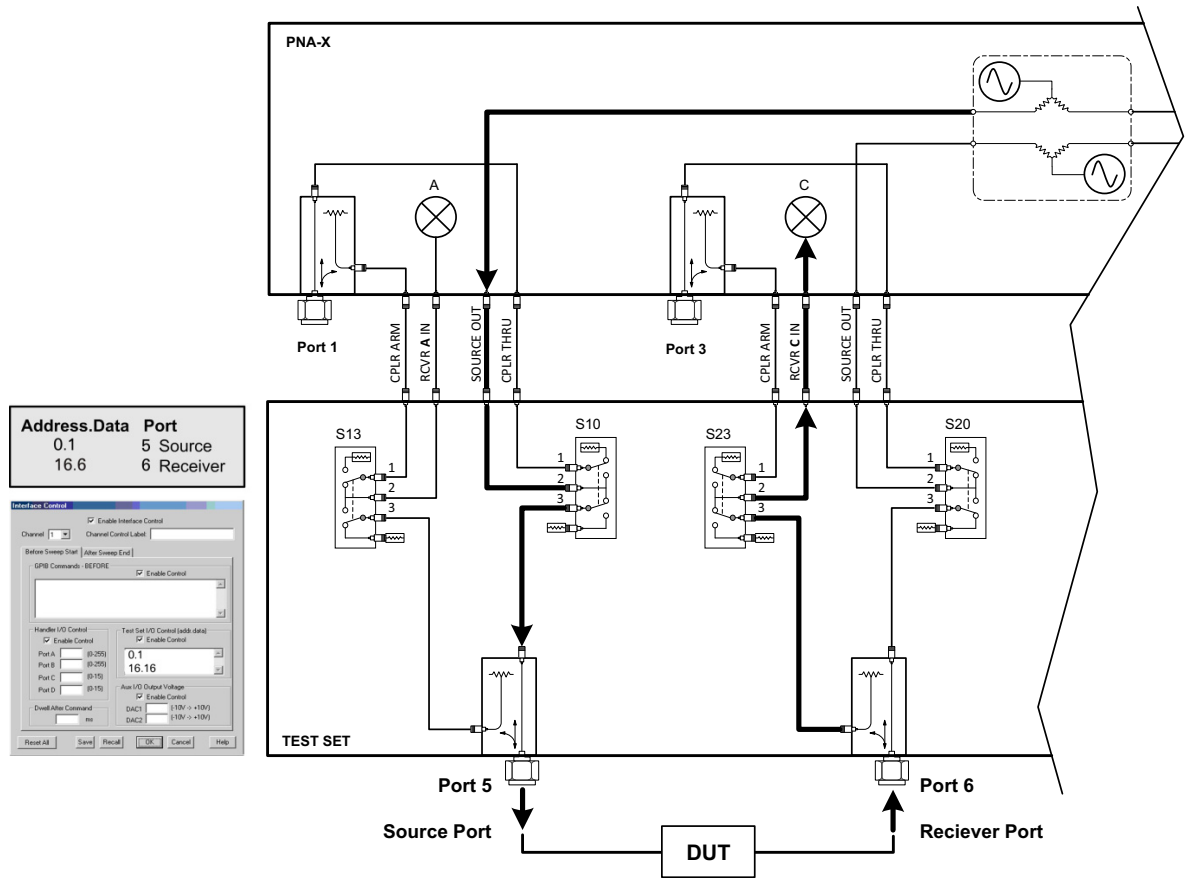

Control Lines

The 15 pin female D-Sub connector on the rear panel provides 8 latched data lines that can be used to control your device under test (DUT). The lines can be controlled with the multiport external test set control, or test set I/O commands. Refer to [“External Test Set Control Operation” on page 24](#) and [“Setting the Control Lines with Address and Data Values” on page 42](#). See [Table 9](#) for DUT control line specification.

The output voltage of the lines can be from the internal adjustable voltage source (+2 to +5 Vdc), or an external dc power supply depending on how the connection to the control line is configured. When using an external power supply a positive or negative voltage can be used. Refer to [Figure 32](#) and [Table 10 on page 39](#) for control line pin location and description. Refer to [“Internal Voltage Supply Configuration” on page 40](#) and [“External Voltage Supply Configuration” on page 41](#) for configurations.

Table 9 DUT Control Specifications

Item	Specifications
Connector Type	D-Sub, 15-pin female
Max Output Line Current	100 mA (each line)
Control Line DC resistance	< 10 W (each line)
Voltage Range:	
Positive Input	0 to +5 V
Negative Input	-5 to 0 V
Internal Variable Voltage	+2 to +5 V

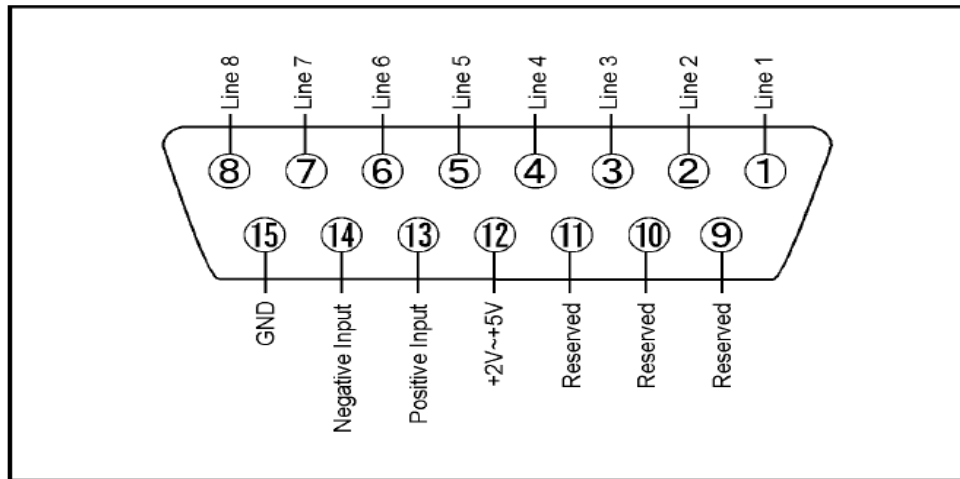
Figure 32 DUT Control Line Pin Assignment (rear panel view)**Table 10 DUT Control Line Interface Connector Pin Assignment**

Pin	Signal Name	Description
1	Line 1	Control Line Output of the voltage from pin 13 or pin 14
2	Line 2	Control Line Output of the voltage from pin 13 or pin 14
3	Line 3	Control Line Output of the voltage from pin 13 or pin 14
4	Line 4	Control Line Output of the voltage from pin 13 or pin 14
5	Line 5	Control Line Output of the voltage from pin 13 or pin 14
6	Line 6	Control Line Output of the voltage from pin 13 or pin 14
7	Line 7	Control Line Output of the voltage from pin 13 or pin 14
8	Line 8	Control Line Output of the voltage from pin 13 or pin 14
9, 10 & 11		Not used
12	+2 V to +5 V	Internal voltage output, adjusted with the trimmer on the rear panel.
13	Positive Input	Connection for internal (pin 12) or external positive voltage supply.
14	Negative Input	Connection for ground (pin 15) or external negative voltage supply.
15	Gnd	ground terminal

Internal Voltage Supply Configuration

The output voltage of pin 12 can be adjusted from +2 to +5 V. Perform the following procedure to set the voltage:

1. Turn *on* the test set.
2. Measure the voltage between pin 12 and 15 using a multimeter.
3. Rotate the voltage adjustment trimmer on the rear panel until the multimeter indicates the selected voltage.

Figure 33 illustrates an example of the connection between the DUT and the test set using the internal dc power supply. Connect pin 12 to pin 13 and pin 14 to pin 15 to provide the ground path. Connect the control lines to the external DUT.

CAUTION You may only connect pin 12–13, and pin 14–15, damage may result if any other paths are short-circuited.

Figure 33 Internal DC Power Configuration (rear panel view)

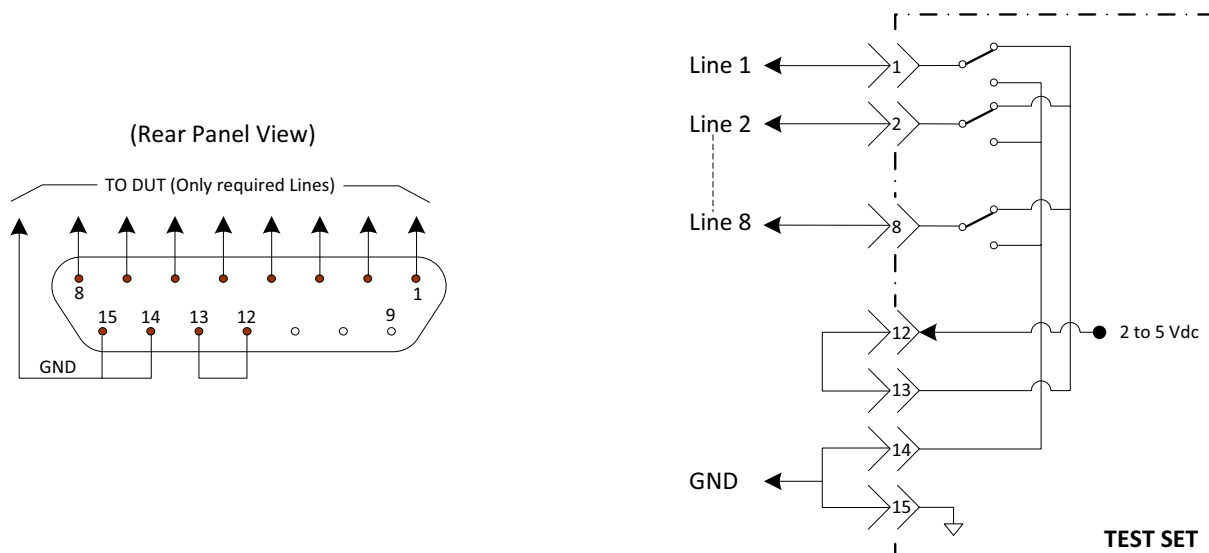

External Voltage Supply Configuration

Figure 34 illustrates an example of the connection with an external dc power supply. Connect the positive and negative voltage supply from the external power supply to the positive input (pin 13) and the negative input (pin 14). Connect the power supply dc ground to pin 15.

Turning On the Test Set using an External Power Supply

1. Turn On the test set.
2. Connect the DUT.
3. Turn On the external power supply.

Turning Off the Test Set using an External Power Supply

1. Turn Off the Power Supply.
2. Turn Off the test set.
3. Disconnect the DUT.

Figure 34 Test Set to the DUT and External DC Power Supply

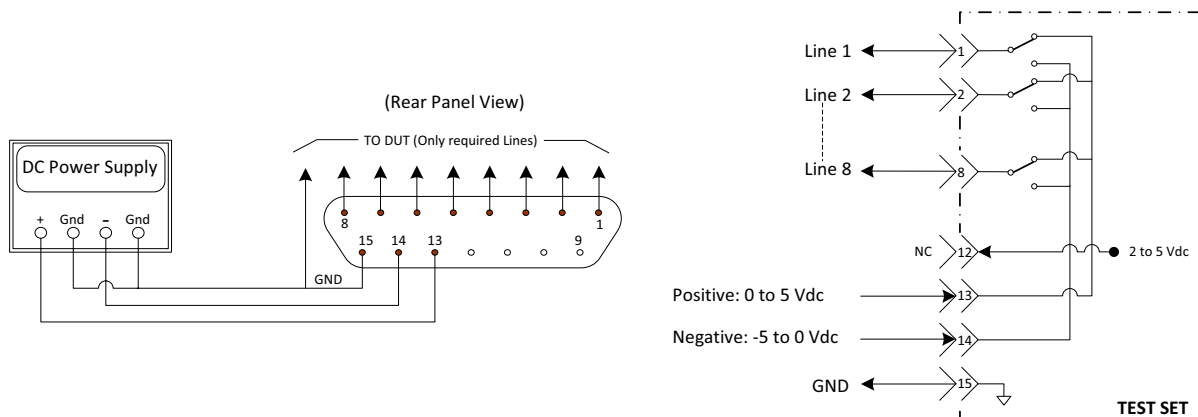

Setting the Control Lines with Address and Data Values

This section describes how to control the rear panel DUT control lines.

NOTE The following control feature will function only while the analyzer is in Standalone Mode.

Setting the Network Analyzer to Standalone Mode

1. Select **Utility > System > Configure > Multiport Capability**. In the dialog box select **Restart as a standalone PNA > OK**.

As described in “[Setting the Test Port Paths with Address and Data](#)” on page 36, the <address>.<data> values are determined in a similar manor, with the following exceptions:

- [Table 11](#) will be used.
- The <address> value is always = 112

Table 11 Test Set DUT Control Address and Data Logic Table

<Address>	<Data>	Description	Line/Pin
112	0	ALL DUT Control Lines set to logic high or connected to Pin 13	1-8
112	255	ALL DUT Control Lines set to logic low or connected to Pin 14	1-8
112	1	DUT Control Line 1 set to logic low or connected to Pin 14	1
112	2	DUT Control Line 2 set to logic low or connected to Pin 14	2
112	4	DUT Control Line 3 set to logic low or connected to Pin 14	3
112	8	DUT Control Line 4 set to logic low or connected to Pin 14	4
112	16	DUT Control Line 5 set to logic low or connected to Pin 14	5
112	32	DUT Control Line 6 set to logic low or connected to Pin 14	6
112	64	DUT Control Line 7 set to logic low or connected to Pin 14	7
112	128	DUT Control Line 8 set to logic low or connected to Pin 14	8

After a power reset all DUT control lines are initially configured to a logic high state or connected to Pin 13, refer to [Figure 33 on page 40](#). To reset all control lines to logic high, without having to reset the power switch on the test set, make the following analyzer entry:

Front panel analyzer Interface Control Mode line entry = 112.0 > OK.

Always determine which control lines you want set to a logic zero, the other remaining lines will automatically be set to a logic high. Note the <data> value of these lines and calculate the SUM of their <data> values.

Listed are two examples to illustrate this concept. Refer to Figure 28, shown with all lines = logic high.

Example 1: To change lines 1 & 8 to equal logic Low, all others logic high.

1. Line 1 (<address> = 112 and <data> = 1)
2. Line 8 (<address> = 112 and <data> = 128)
3. The SUM of the <data> values = 129
4. Front panel analyzer Interface Control Mode line entry = 112.129 > OK.

Example 2: From Example 1 to only change Lines 2 & 3 to equal logic low, all others logic high.

1. Line 2 (<address> = 112 and <data> = 2)
2. Line 3 (<address> = 112 and <data> = 4)
3. The SUM of the <data> values = 6
4. Front panel analyzer Interface Control Mode line entry = 112.6 > OK.

NOTE Since all control lines have the same <address>, only one "<address>.<data>" command line is needed to control all 8 lines.

Cal Kit Operational Check

The following procedure can be used to confirm the 1-Port Cal operation of an ECal module or Mechanical Cal Kit with the U3047AM04 Test Set. The operation verification limits provided ensure that your U3047AM04 and network analyzer are operating properly. Refer to [“Verifying Cal Kit Operational Check Failure” on page 49](#) to ensure the RF interface cables are installed and working correctly before returning the test set for repairs.

Verification Limits

Specifications for the test set are typical. System performance for the analyzer and test set are only characteristic and intended as non-warranted information. Only a functional certificate is provided for the test set.

It is recommended that you return your instrument to Agilent Technologies for servicing or repair if the test set and analyzer performance exceed the operational verification limits.

A periodic calibration is not required. The Operators Check should be performed after System Setup, or if performance is in question. An N-Port calibration should be performed before making a measurement. Refer to [Table 5 on page 9](#).

NOTE If you suspect that your 8-Port configuration is not operating properly, ensure that all front RF jumper interconnect cables are correctly attached.

Table 12 System Verification Limits¹

Frequency	Ports 1 to 4	Ports 5 to 8
10 MHz to 500 MHz	-2	-2
500 MHz to 3.2 GHz	-3	-3
3.2 GHz to 10 GHz	-4	-4
10 GHz to 16 GHz	-5	-4
16 GHz to 20 GHz	-6	-5
20 GHz to 26.5 GHz	-8	-5
26.5 GHz to 43.5 GHz	-9.5	-6
43.5 GHz to 50 GHz	-11	-6
50 GHz to 67 GHz	-12	-7

1. Reflection Tracking takes into account Source Loss, Receiver Loss, Margin and network analyzer Mixer Cal.

Equipment Required

The Agilent U3047AM04 requires that the user be familiar with the equipment listed.

Table 13 Equipment List

Description	Qty
N4694A 1.85 mm ECal Module 10 MHz - 67 GHz (Option 00F or M0F) <i>or</i> 85058B Verification Kit.	1
N5247A Option 400 and 551	1
Set of interconnect cables (network analyzer and test set), see “N5247A or N5227A RF Interface Cable Connections (U3021-60101)” on page 16.	1

Operational Check Procedure

The sequence of this procedure is very important and must be followed or the performance accuracy and results may vary from the reference plots provided. Ensure that the test set is not connected to the analyzer if you are performing an Operator’s Check. The analyzer will indicate false failures if the test set is connected.

Preparing the N5247A or N5227A

1. Connect the test set to the 4-Port analyzer using the interconnect cables as shown in [Figure 10 on page 16](#) and [Table 6 on page 16](#).
2. Turn *on* the test set.
3. Select **Response > Cal > Manage Cals > Cal Set**. Delete or Rename any Cal Sets titled “999.1” thru “999.8” (8-Port), although it is unlikely that you will find Cal Sets with these names.
4. Verify that the analyzer is in Multiport mode. See the bottom of the measurement window.
 - a. If only four S-Parameters are listed, select **Utility > System > Configure > Multiport Capability**. Select **Restart as multiport PNA with this testset** and select **U3047AM04 (8-Port)** from the drop-down menu > **OK**. Refer to [Figure 18 on page 23](#).
5. Press **Preset**.
6. Verify that the **[Start Frequency]** is set to **[10 MHz]**.
7. Set the **[Stop Frequency]** is set to **[67 GHz]**
8. Select **[Power] > Power Level** and enter **[-15 dBm]**.
9. Select **Response > Avg > IF Bandwidth > 100 Hz > OK**.
10. Select **Stimulus > Sweep > Number of Points > 401**.
11. Connect the ECal module to an available USB port on the front or rear panel of the analyzer. Refer to [Figure 10 on page 16](#). This procedure assumes you are using an ECal. If you are not, see “1-Port Calibration and Verification Procedure” on page 46, step 2.
12. Allow the ECal module, test set and analyzer to warm up for a minimum of 30 minutes.

1-Port Calibration and Verification Procedure

1. Connect the ECal or the mechanical cal kit to Port 1 or the port you are testing. Torque to 8 in-lb. For further information refer to the Help menu, see [Figure 35](#).
2. Perform a 1-Port Calibration on Port 1. On the analyzer, select **Response > Cal > Start Cal > Calibration Wizard**.
 - a. If using a mechanical cal kit, select **SmartCal (Guided Calibration) > Next**.
 - b. If using an ECal module, connect the ECal to a analyzer's USB port. Select **Use Electronic Calibration (ECal) > Next**.
3. Continue following the Cal Wizard prompts. In the Select Calibration Ports and ECal Module dialog box click **Clear All**, then select **Port 1 > Next > Measure**.

Figure 35 1-Port Calibration

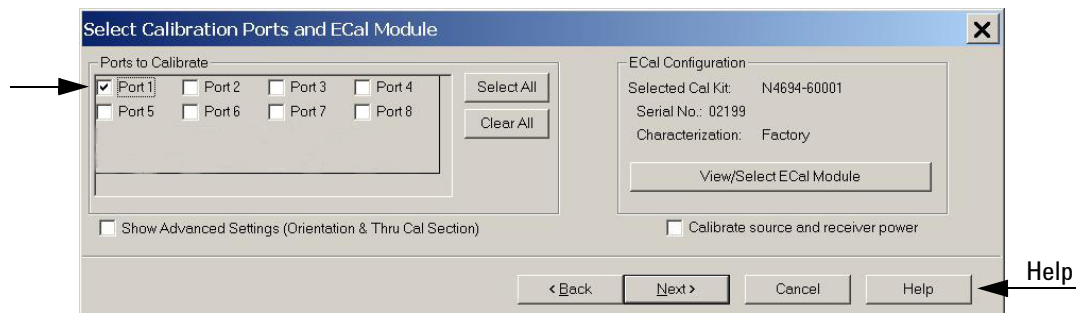

4. Continue to follow the prompts until the Calibration Completed dialog box appears.
5. At the Calibration Completed prompt, select **Save As User Calset**, type the name **999.1**. Overwrite the Calset if it already exists and **Save**.

NOTE If you do not have a key board, select **Save As User Calset > Edit Name** and save as **999.x**. X is the port number you are calibrating. Use the numeric keypad on the analyzer's front panel to enter "999.1."

Figure 36 Calibration Complete

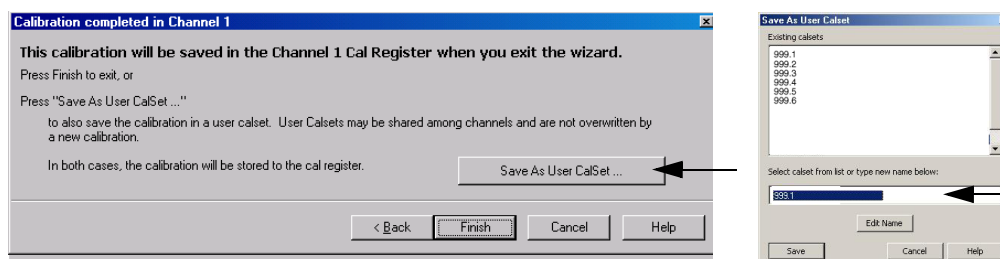

6. Repeat [step 1](#) thru [step 5](#) for Ports 2 thru 8. When finished, there should be 8 Cal Sets saved with the titles “999.1” thru “999.8” (8-Port).
7. Select **Trace/Chan > Trace > Delete Trace**. There should be no traces on the display.
8. To launch the Cal Set Viewer toolbar. Select **Response > Cal > Manage Cals > Cal Set Viewer**.

Figure 37 Calibration, Cal Set Viewer

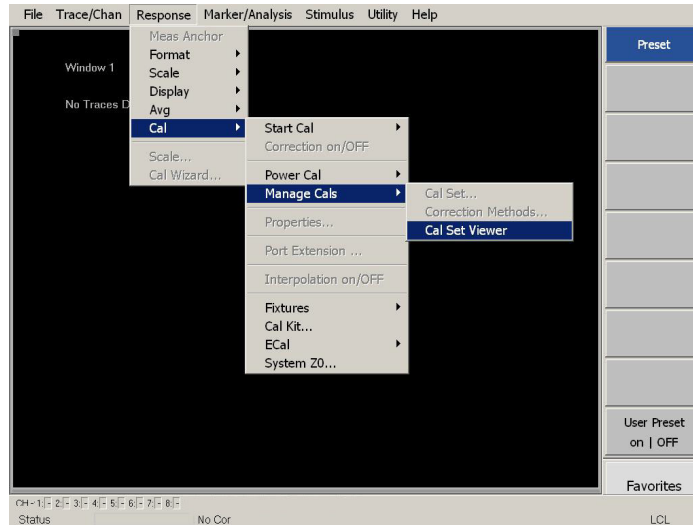

9. From the Cal Sets drop-down menu, select **999.1** and select **Enable**. Select the **Reflection Tracking(x,x)**, where x,x is the port being tested. Ensure that the **Enable** and **Error Terms** check boxes are selected.
10. Compare the Reflection Tracking (1,1) trace to the appropriate limits in [Table 5 on page 9](#). The trace should be above the limit.
11. Repeat [step 9](#) and [step 10](#) for Cal Sets “999.1” thru “999.8” (8-Port).

Figure 38 Standard Reflection Tracking Trace (Ports 1 to 4)

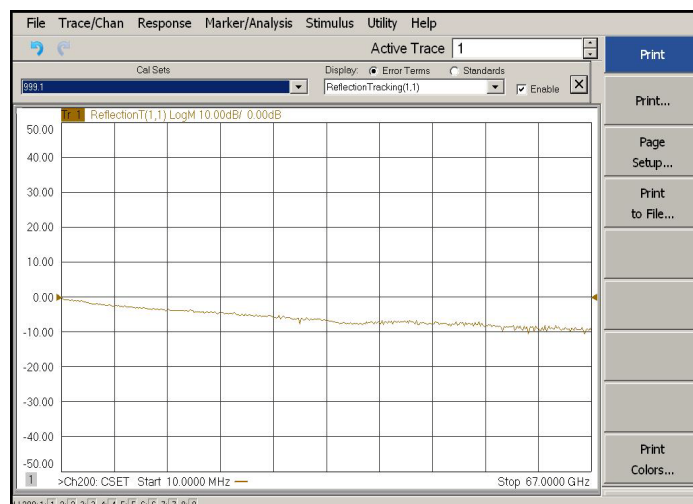
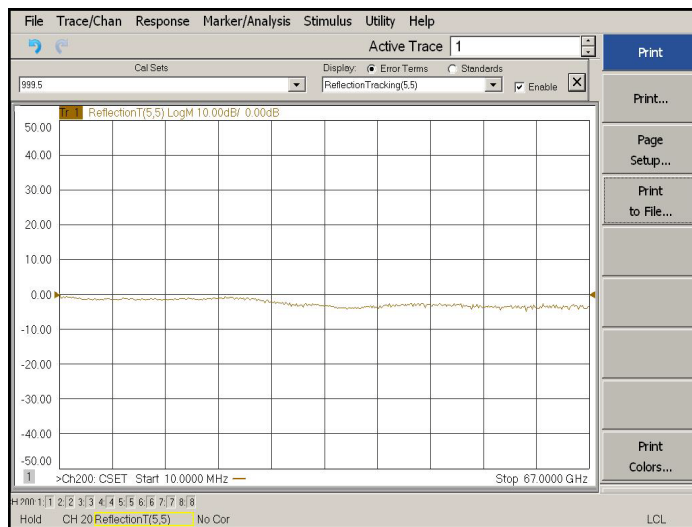

Figure 39 Standard Reflection Tracking Trace (Ports 5 to 8)

If you are using an ECal module you can verify the individual port calibration.

1. Select **Response > Cal > More > ECal > ECal Confidence Check**.
2. Click **Change Measurement** and select the test port S-Parameter > **Apply > OK**.
3. Click **Read Module Data**.

For further information refer to the Help menu.

Verifying Cal Kit Operational Check Failure

If your test results fail the Cal Kit Operational Check limits, see [Table 5 on page 9](#). Verify the following verify following:

1. Ensure that the test set is turned On and connected properly to the analyzer.
2. Check all appropriate analyzer and test set connectors for damage, cleanliness, and proper torque.
3. Repeat the relevant 1-Port calibrations using another ECal or mechanical standard.
4. Verify that the analyzer is operating properly and meeting its published specifications. If the analyzer is connected to the test set it will fail the Operational Check. Refer to “[Network Analyzer Requirements](#)” on page 4.

ECal Confidence Check

The following procedure is a method to check the accuracy of a 1-Port calibration performed with mechanical standards or an ECal module. In order to perform this check, the test port of the ECal module must connect directly to the test port being verified (without adapters).

1. Perform a 1-Port calibration on the test set port being tested.
2. Connect the ECal Module to the port being tested. Terminate any remaining ports on the ECal Module.
3. Select the Cal Set to be tested. Select **[CAL] > Cal Set > Cal_File > Apply Cal > Close**. If the Choose Stimulus Settings prompt appears, Select **Change the active channel's stimulus. > OK > Close**.
4. Select **[Response] > Cal > More > ECal > ECal Confidence Check**.

Figure 40 ECal Confidence Check

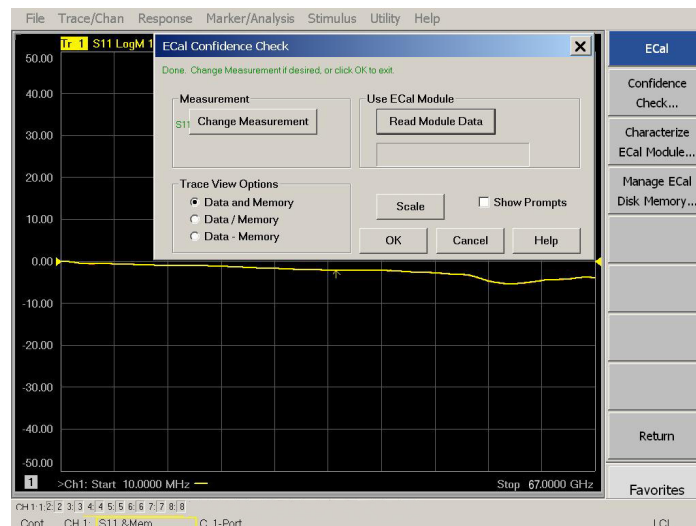

5. ECal Confidence Check dialog box: Click **Change Measurement** and select the test port S-parameter > **Apply** > **OK**. Click **Read Module Data**.
6. Select ECal Module dialog box: Select the ECal Module you are using, and select the **ECal Module Memory and Factor ID** > **OK**.

Figure 41 ECal Confidence Check Trace

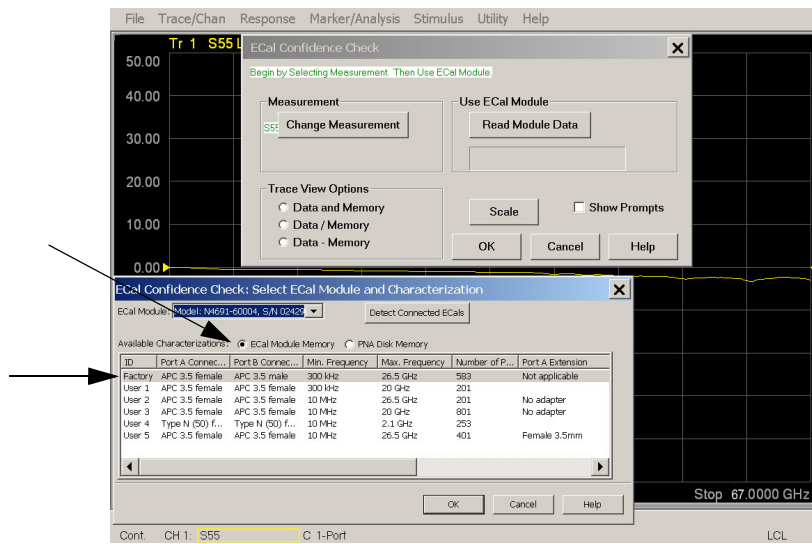

Service Information

This section provides information to troubleshoot and repair the U3047AM04 Test Set. Refer to “[Agilent Support, Services, and Assistance](#)” on page 74 for information on returning your test set to Agilent Technologies.

WARNING **No operator serviceable parts inside. Refer servicing to qualified personnel. To prevent electrical shock do not remove covers.**

WARNING **These servicing instructions are for use by qualified personnel only. To avoid electrical shock, do not perform any servicing unless you are qualified to do so.**

Replaceable Parts

The following replaceable parts are available from Agilent Technologies “Find-A-Part” system on the web at www.parts.agilent.com.

Table 14 **Available Replacement Parts (SPO)**

Description	Agilent Part Number
Switch, Multiport (67 GHz terminated)	N1811-60019
Fuse (5 A 250 V non-time delay Socket)	2110-0709
Fuse (8 A 250 V non-time delay 0.0146 Ohm)	2110-0342
PWR Supply (AC/DC SWG 650W 9- Output)	0950-4729
Couplers	5087-7254
Network Analyzer Locking Feet	5023-0132
Test Set I/O Cable	N4011-21002
Fan (rear panel)	87050-60027
DUT Control Board	E5091-66503

The following replaceable parts may be ordered by sending an e-mail request to ctd-soco_support@agilent.com. Be sure to include test set model, options and serial number. Some parts may have long lead times.

Table 15 Replaceable Parts (M04)

Description	Agilent Part Number
RF Cable, Semi-rigid	U3047-20016
RF Cable, Semi-rigid	U3047-20017
SW Interface Board, programmed	U3025-60068
Dress Nut (couplers)	N5230-20081
Test Set Rear Lock Feet (right)	N5242-20138
Test Set Rear Lock Feet (left)	N5242-20139
Front Panel LED Board (programmed)	N5261-60005
Test Set Control Board (programmed)	N5261-60006
2.4 mm Short (female)	85056-60021
Screw-Pan Head Machine with thread patch, Torx-T15 M3.5 with 0.6 thread, 12 mm-LG	0515-2317
U3047A-M04 User's and Service Guide	U3047-90003
Hardware kit to secure the network analyzer to the test set	U3021-60002
RF-Cable Kit to connect network analyzer to the test set	U3021-60101

System Block Diagram

Figure 42 RF Block Diagram

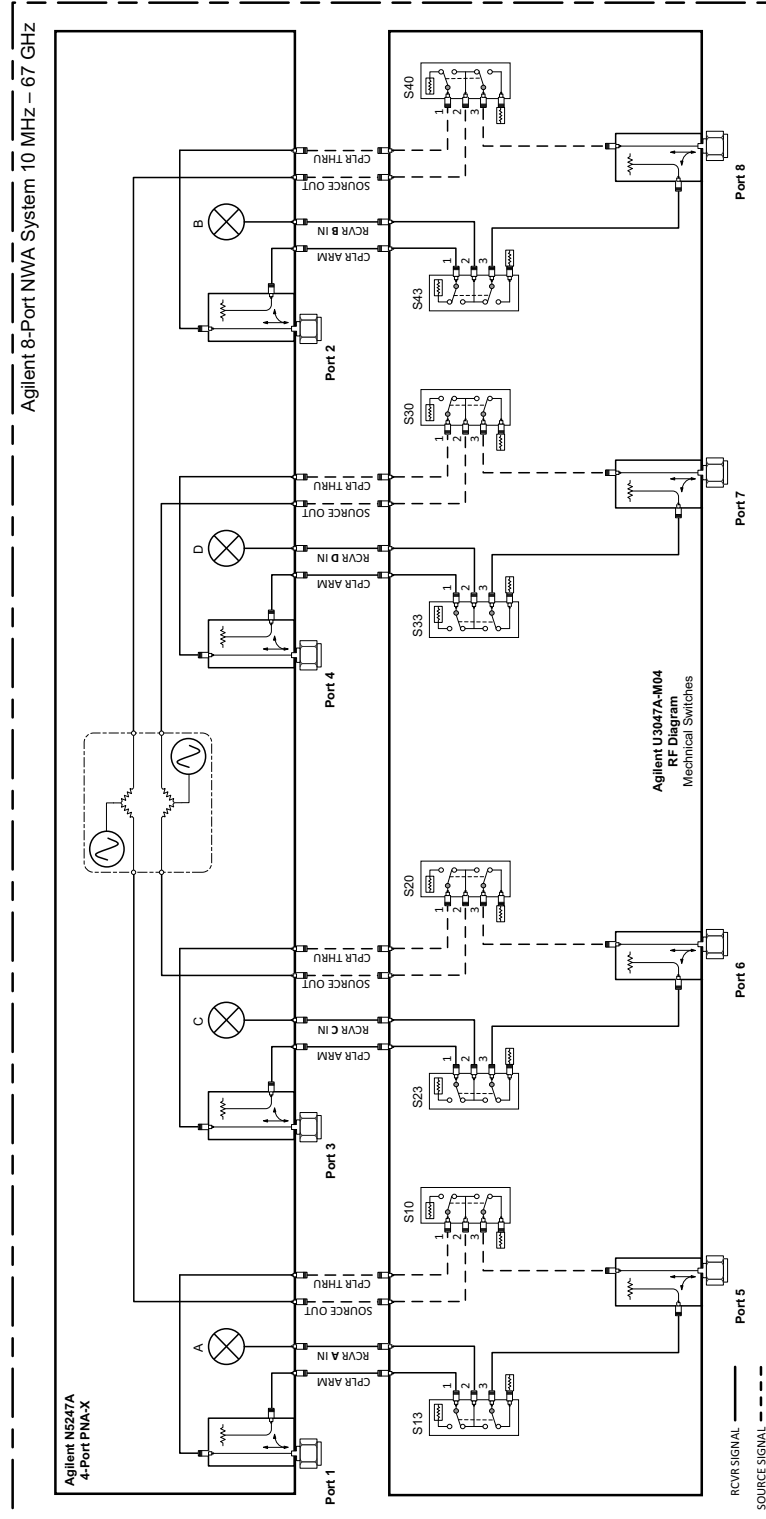
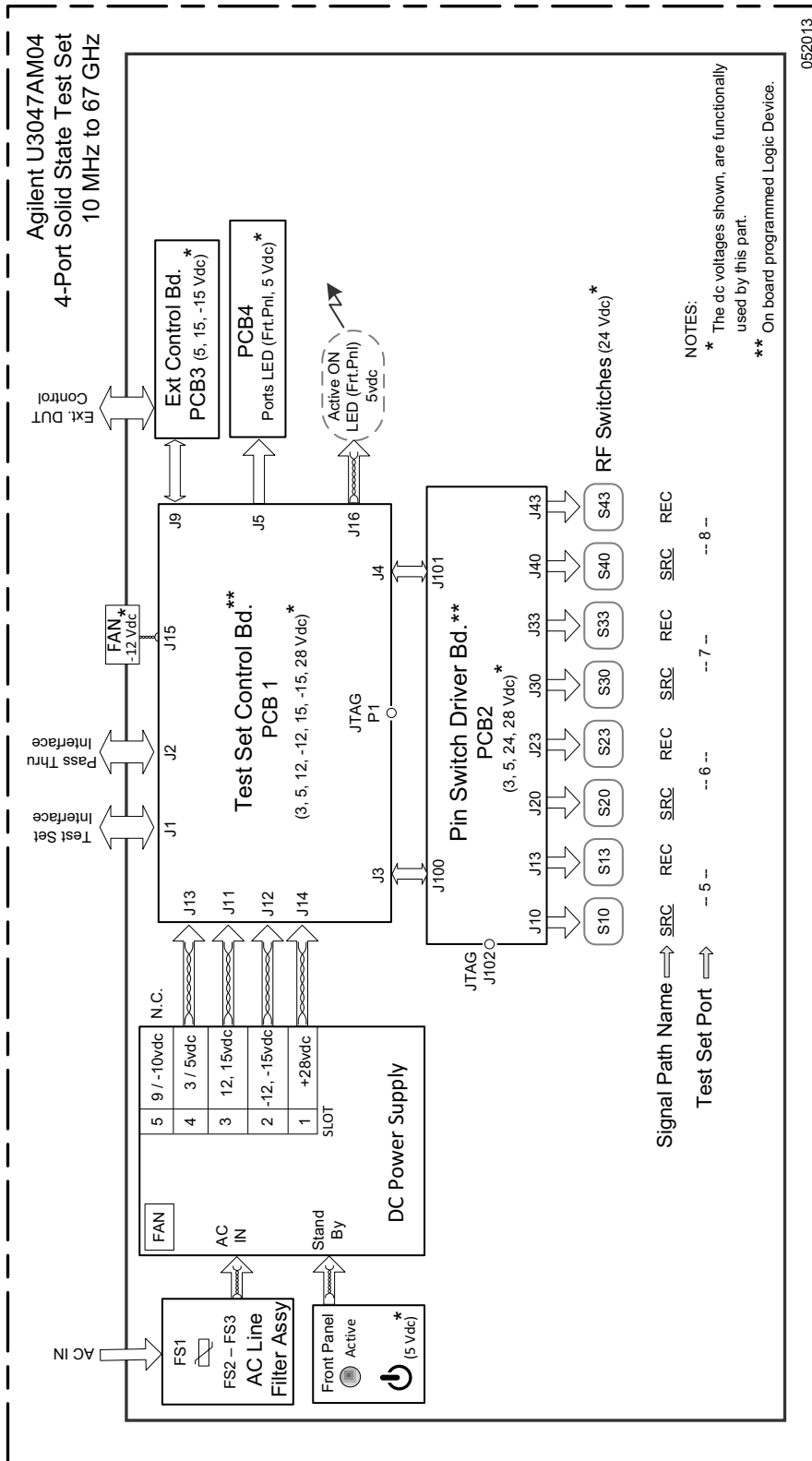

Figure 43 Electrical Block Diagram



Theory of Operation

The following is a description of the operation of the test set. Reference the test set block diagrams shown in [Figure 42 on page 53](#). This section assumes the user has a general understanding of couplers, switches, and network analyzers.

The test set adds 4 test ports to a 4-Port network analyzer. The internal RF switches direct the source and receiver signals of the analyzer to the selected measurement test port.

The switches and couplers are arranged in four groups to control the source and receiver paths of the analyzer port to the couplers in the column under the analyzer port.

Test Set Control Board

The Test Set Control Board (N5261-60006) is a surface mount, printed circuit assembly (PCA). It provides a connection to the power supply, and the analyzer's Test Set I/O for control of the RF switch paths (through the Switch Interface board (U3025-60068). The front panel "Active" and port LEDs are on only when the analyzer has addressed the U3047AM04 test set. The rear panel fan is on when the controller board supplies are operational.

Switch Interface Board

The Switch Interface board (U3025-60068) is installed on top of the test set Controller Board and provides connections to the RF switches. This board regulates the DC voltage supply (24 volts), and routes logic signals to the switches through harness cables connected to plugs J10, J13, J20, J23, J30, J33, J40 and J43.

Front Panel LED Boards

One LED board assembly (N5261-60005) is mounted to the front panel. The LED's indicate the Source Path (amber/yellow color), or Receiver Path (green colored) shown as "S" and "R" on the front panel. The LED board assembly is connected to the test set controller board by ribbon cables.

DUT Control Board

The DUT Control Board (E5091-66503) provides eight control lines for controlling an external device. The DUT Control Board installed on the rear panel and is connected to the test set Control Board through a ribbon cable to J9.

Power Supply

The switching power supply (0950-4729) converts the AC line voltages to DC. This is an automatic line voltage selecting power supply. The DC supplies are connected to the test set control board through four wire harness to J11, J12, J13 and J14. The 9/10 Vdc section of the power supply is not used in this instrument. The AC line voltage (100 to 240 V @ 50/60 Hz) is provided from the line module on the rear panel.

RF Coupler

The test set uses 4 couplers (5087-7754) on the front panel for RF Test Ports 5-12. The couplers provide the signal separation of the source and receiver paths. The test set ports can receive from or stimulate a signal to the DUT.

The RF Test Port connectors are male 1.85 mm. The coupling factor is approximately -18 dB for the Coupled Arm for frequencies > 1 GHz to 67 GHz (approximately -53 dB < 1 GHz). The insertion loss through the CPLR THRU path is typically < 4 dB at 67 GHz.

RF Switch Components

The test set uses 8 mechanical switches that have internal 50 Ω termination and a external 50 Ω termination (85058-60123). The switches select the RF paths from the analyzer source and receiver through interconnect cables to the test set.

Source and Receiver Switch Paths

SW10 - Source to Ports (1 and 5) provides control of the Source Output path to Analyzer Port 1 and Test Set Port 5. In the state shown in the block diagram, switch 10 routes the RF Source back to the Analyzer Port 1, and the Test Set Source path to Port 5 is terminated.

SW20 - Source to Ports (3 and 6) provides control of the Source Output path to Analyzer Port 3 and Test Set Ports 6, 10 and 14. In the state shown in the block diagram, switch 20 routes the RF Source back to the Analyzer Port 3, and the Test Set Source path to Port 6 is terminated.

SW40 - Source to Ports (2 and 8) provides control of the Source Output path to Analyzer Port 2 and Test Set Port 8. In the state shown in the block diagram, switch 40 routes the RF Source back to the Analyzer Port 2, and the Test Set Source path to Port 8 is terminated.

SW23 - Receiver to Ports (3 and 6) provides control of the Receiver Input path to Analyzer Port 3 and Test Set Port 6. In the state shown in the block diagram, switch 23 routes the Port 3 Coupler Arm to the Receiver, and Test Set Port 6 Coupler Arm path is terminated.

SW33 - Receiver to Ports (4 and 7) provides control of the Receiver Input path to Analyzer Port 4 and Test Set Port 7. In the state shown in the block diagram, switch 33 routes the Port 4 Coupler Arm to the Receiver, and Test Set Port 7 Coupler Arm path is terminated.

SW43 - Receiver to Ports (2 and 8) provides control of the Receiver Input path to Analyzer Port 2 and Test Set Port 8. In the state shown in the block diagram, switch 43 routes the Port 2 Coupler Arm to the Receiver, and Test Set Port 8 Coupler Arm path is terminated.

Troubleshooting the Test Set

If the U3047AM04 is not operating properly, use the following procedures to isolate and repair the type of failure encountered. It is recommended that a qualified service technician perform the following procedures.

Refer to the Agilent PNA Series: Service & Support Home Page at: <http://na.tm.agilent.com/pna> for further information.

To request service, please contact your local service center. In the US, call 800-829-4444. For a listing of service centers worldwide, please visit us at www.agilent.com/find/service.

WARNING **No operator serviceable parts inside. Refer servicing to qualified personnel. To prevent electrical shock do not remove covers.**

Non-RF Failures

Typical malfunctions may be the rear panel fan, control lines or front panel indicator lights.

1. Verify that the front panel Power Switch is operational.
 - a. The rear panel fan and front panel Active LED should operate when the Standby Switch is in the On position.
2. AC line voltage checks (remove AC power from the instrument).
 - a. Ensure the proper AC line voltage is present at the instrument line cord.
 - b. Remove the AC power cord from the instrument. Confirm the instrument AC line module fuse is operational. See [Figure 4 on page 12](#).
 - c. Internal AC line fuses - Remove the bottom cover of the instrument. Near the rear panel are two fuse holders, remove the fuses and verify that they are operational. Refer to [Figure 51 on page 67](#).

WARNING **The opening of covers or removal of parts is likely to expose the user to dangerous voltages. Disconnect the instrument from all voltage sources before being opened.**

3. Internal DC Power - During this check you will apply AC power to the instrument with the top cover removed. Connect the AC power cord to the test set.
 - a. Set the front panel switch to the Standby position. The fans and indicator lights should be Off.
 - b. Set the standby switch to the On position. The rear panel and internal power supply fans should be operational. The Active LED will be On when the test set is connected to an active network analyzer and is addressed by the network analyzer.
 - c. Verify that the DC LEDs indicators are On.

Note: The LEDs only indicate the presence of a DC voltage, not the DC voltage level. Use the indicated wire locations for voltage measurements, TP1 is your common. Refer to [Figure 44 on page 58](#).

- d. If there is no DC power, suspect the power supply module. The actual power supply terminal connection should also be confirmed with a DVM by removing the bottom cover and using the power supply label to identify the terminal voltage values.
- e. If all of the DC Input LEDs are On and the fan is not working, replace fan.

NOTE The +9 and -10 Vdc indicators are not used in this instrument (Off is normal).

Figure 44 DC Power Status LEDs

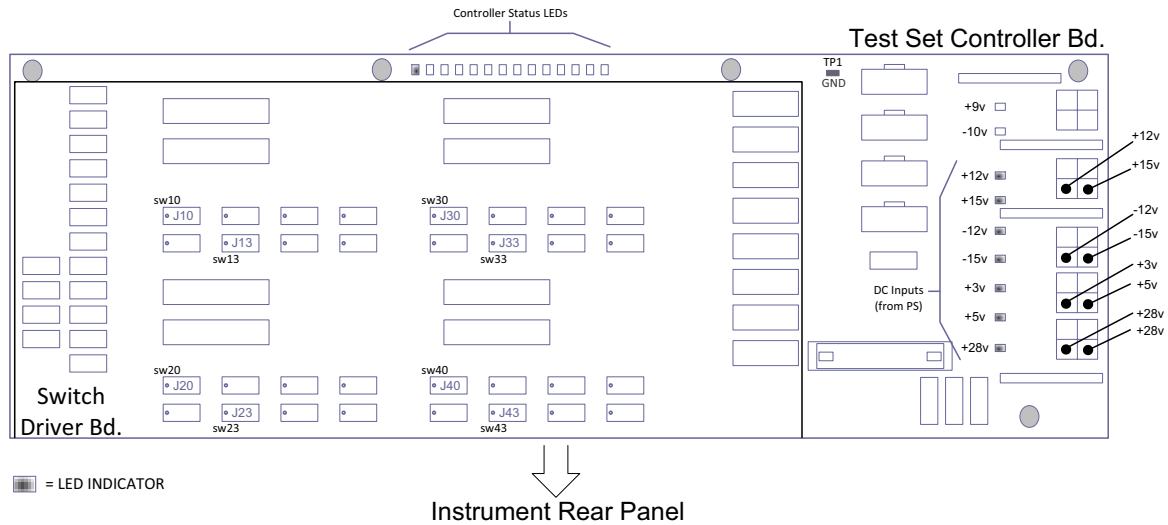

4. Front panel R and S indicator LED check.

- a. If the indicators are not operating, continue to “RF Switching Failures,” step 1 and step 2.

5. Control Lines are not working.
 - a. Verify that the control voltage pin connections to the DUT control lines are connected properly. Refer to [“Control Lines” on page 38](#).
 - b. Verify that the rear panel DC voltage control adjustment can be set to 5 Vdc. Refer to [Figure 3 on page 11](#).
 - c. Remove the instrument top cover. Using a DVM, verify that the three DC voltage inputs are present on the DUT control board (E5091-66503). Refer to [Figure 45](#).
 - d. If the DC voltages are normal, then replace the DUT control board. If the voltages are not present, check the ribbon cable and its connections at both ends. Suspect the test set Control board as the possible problem.

Figure 45 DUT Control Board DC Voltage Locations

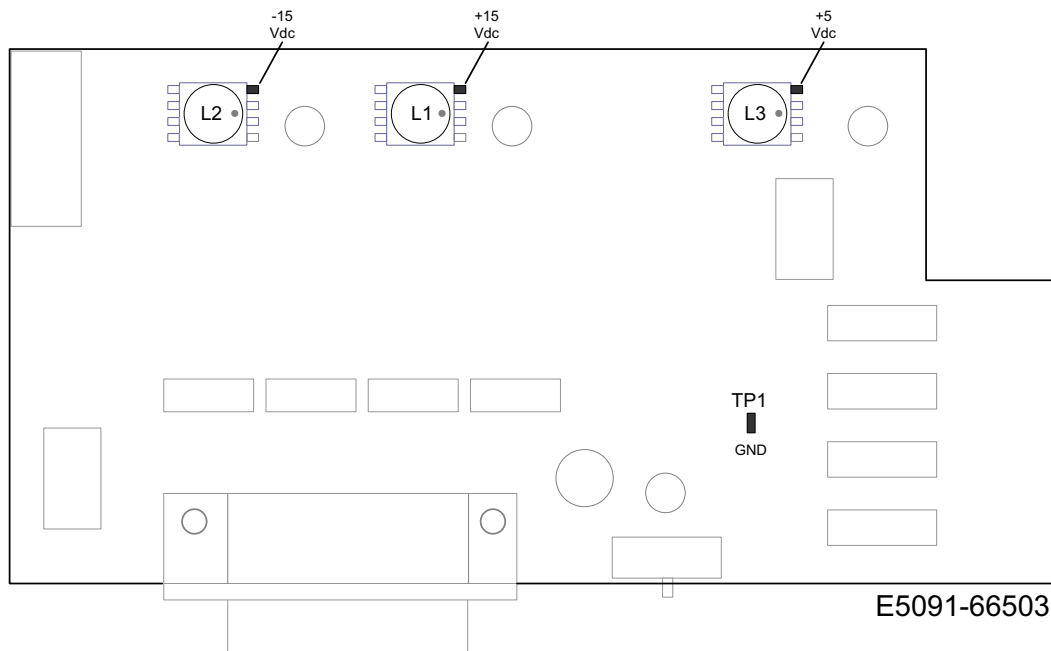

RF Switching Failures

Typical failures may be the loss of RF switch control failure or a non RF failure as outlined in the prior section. The internal RF switches used in this instrument are controlled by the +24 Vdc from the Switch Driver board.

1. Confirm that the analyzer and test set are properly connected using the test set I/O cable (N4011-21002). See [Figure 11 on page 17](#).
2. Using Multiport Mode (Option 551), verify that the analyzer's firmware is correct, and that the test set file is loaded into the analyzer. Refer to ["Network Analyzer Requirements" on page 4](#).
3. Using the I/O command values, confirm that the correct address and data values are used. Refer to ["Address and Data Values" on page 36](#).
4. Follow the ["Non-RF Failures" on page 57](#) procedure (if not already done so).
5. Front Panel R and S indicator LED Check.
 - a. Confirm that the test set Controller Board Status LED's are On. Refer to [Figure 44 on page 58](#). If the LED's are Off remove the Switch Driver board, if the LED's remain Off replace the Controller board.
 - b. If the Status LED's are On and the front panel Active LED is On, suspect the front panel LED board or the ribbon cable (replace as needed).
6. Confirm the DC +24 Vdc switch drive voltages on the Switch Driver Bd by connecting a voltmeter to one of the Jxx locations as shown in [Figure 45 on page 59](#). Do not disconnect the RF Switch connector, this will keep the switch in place as a load for the following voltage measurement.

Figure 46 Switch Drive Voltage Check

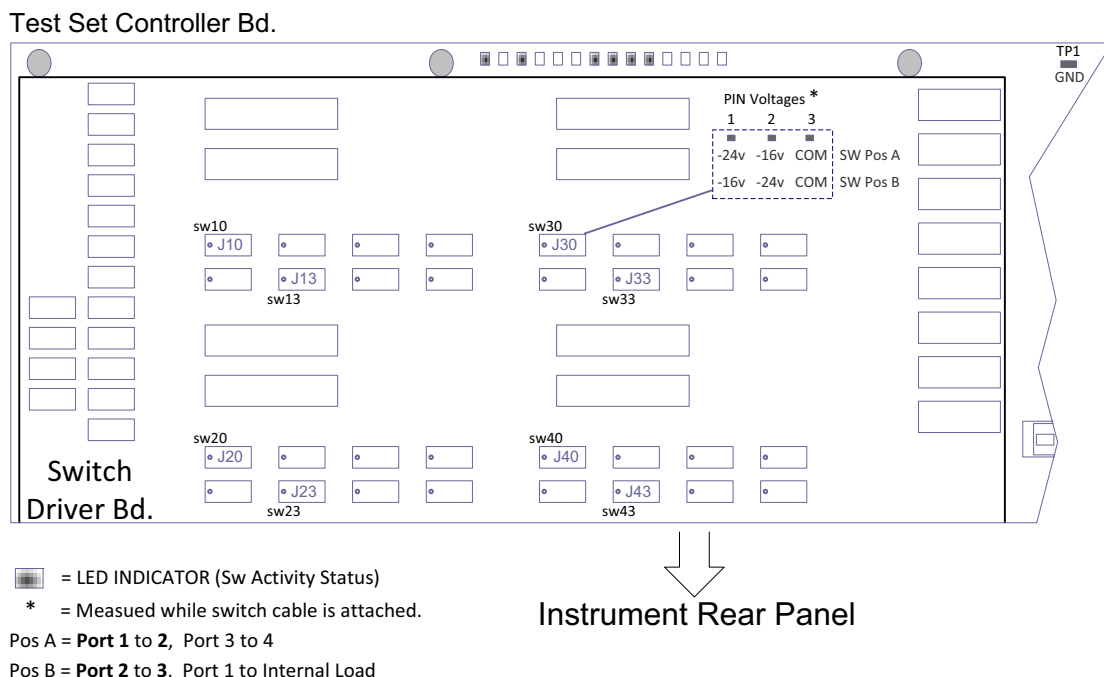

Test Set RF Switching Path

If you suspect an RF signal path problem with the test set and have verified that the problem is not the front panel RF interface cables, the following procedure will check all of the RF signal paths through the test set. Path checks 1 to 4 are from the front panel test ports to the analyzer's source and receiver interconnect ports. Path checks 5 and 6 are test set bypass signal paths for the analyzer's ports 1 to 4.

- Install the test set interface cable from the analyzer to the test set's rear panel.
- Remove the front panel RF interface cables and reinstall the analyzer's front panel jumper cables.

Equipment Required

- N5247A PNA-X or equivalent network analyzer
- Two 67 GHz, 1.85 mm RF Flex Cables
- 1.85 mm Adapters (female to female)
- Test Set Interface Cable

Equipment Setup

1. Turn On the test set and the analyzer.
2. **Presets** the analyzer and set it to **Standalone Mode**. Select **Utility > System > Configure > Multipoint Capability**. In the dialog box select **Restart as a standalone PNA > OK**.
3. Confirm the frequency range is set to 10 MHz to 67 GHz.
4. Connect the RF flexible cables to Port 1 and 2. Connect the cables together using a 1.85 mm adapter.
5. Configure the analyzer to measure S21 and normalize the response trace.
6. Set the analyzer to **Interface Control Mode**: Select **Channel > Hardware Setup > More > Interface Control...** and click **Enable Interface Control box**.

NOTE The <addr>.<data> entries noted in the following Test Instructions table will be used to configure the RF switches for this testing. After making your entry select <OK> to execute the command, to return back for further entries, select Interface Control on the analyzer's display.

Cable Connections

The RF flex cables will be connect to the designated test set front panel ports and an uncorrected response trace should resemble the figures indicated in [Table 16](#).

Table 16 RF Signal Path Insertion Loss (S21)

RF Path Description	Signal	Insertion Loss (typical)
Source IN to Ports 5-8	Source	Figure 47 on page 62
RCVR OUT to Ports 5-8	Receiver	Figure 48 on page 63
Source IN to CPLR THRU	Source	Figure 49 on page 64
RCVR OUT to CPLR ARM	Receiver	Figure 49 on page 64

Source Signal Path Insertion Loss Test

Connect the RF Flex cables to the Test Port and Source IN port indicated in [Table 17](#), the expected results should be similar to [Figure 47](#).

Table 17 Source Signal Path Test Instructions

Path #	RF Path Description	Control Mode <Address>.<Data>	Path Components	Insertion Loss (typical)
1	Source IN to Port 5 ¹	0.1	P5 CPLR, S10 & 11	Figure 47 on page 62
2	Source IN to Port 6	16.1	P6 CPLR, S20 & 21	Figure 47 on page 62
3	Source IN to Port 7	32.1	P7 CPLR, S30 & 31	Figure 47 on page 62
4	Source IN to Port 8	64.1	P8 CPLR, S40 & 41	Figure 47 on page 62

1. Use the Source IN port associated with this group of test ports.

Figure 47 Source IN to Ports 5 to 8 Path Response

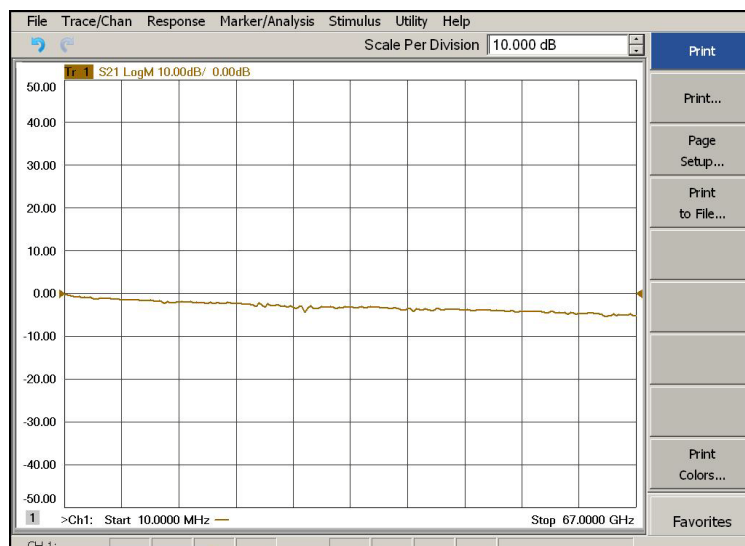

Connect the RF Flex cables to the Test Port and RCVR OUT port indicated in [Table 18](#), the expected results should be similar to [Figure 48](#).

Table 18 Receiver Signal Path Test Instructions

Path #	RF Path Description	Control Mode <Address>.<Data>	Path Components	Insertion Loss (typical)
1	RCVR OUT to Ports 5 ¹	0.16	P5 CPLR, S13 & 14	Figure 48 on page 63
2	RCVR OUT to Ports 6	16.16	P6 CPLR, S23 & 24	Figure 48 on page 63
3	RCVR OUT to Ports 7	32.16	P7 CPLR, S33 & 34	Figure 48 on page 63
4	RCVR OUT to Ports 8	64.16	P8 CPLR, S43 & 44	Figure 48 on page 63

1. Use the RCVR OUT port associated with this group of test ports.

Figure 48 RCVR OUT to Ports 5 to 8 Path Response

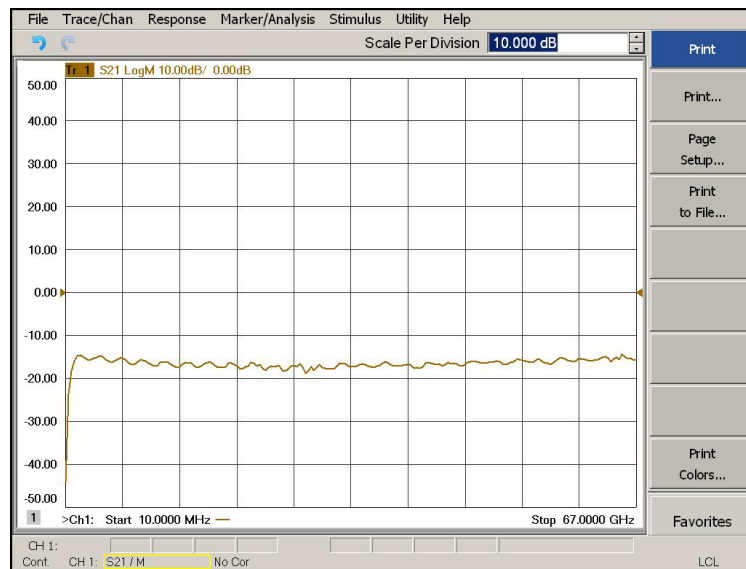

Connect the RF Flex cables to the Source IN and CPLR THRU port indicated in [Table 19](#), the expected results should be similar to [Figure 49](#).

Table 19 Source Bypass Signal Path Test Instructions

Path #	Test Port Group	RF Path Description	Control Mode <Address>.<Data>	Path Components
1	Port 5	Source IN to CPLR THRU	0.0	S10
2	Port 6	Source IN to CPLR THRU	16.0	S20
3	Port 7	Source IN to CPLR THRU	32.0	S30
4	Port 8	Source IN to CPLR THRU	64.0	S40

Figure 49 Source IN to CPLR THRU & RCVR OUT to CPLR ARM Path Response

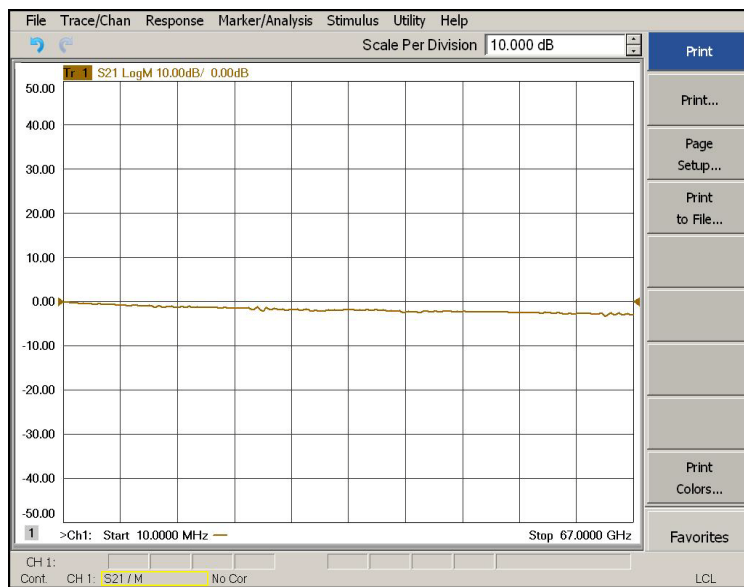

Connect the RF Flex cables to the Source IN and CPLR ARM port indicated in [Table 20](#), the expected results should be similar to [Figure 49 on page 64](#).

Table 20 Receiver Bypass Signal Path Test Instructions

Path #	Test Port Group	RF Path Description	Control Mode <Address>.<Data>	Path Components
1	Port 5	RCVR OUT to CPLR ARM	0.0	S13
2	Port 6	RCVR OUT to CPLR ARM	16.0	S23
3	Port 7	RCVR OUT to CPLR ARM	32.0	S33
4	Port 8	RCVR OUT to CPLR ARM	64.0	S43

RF Performance Failures

If the U3047AM04 operates correctly, but RF performance fails the operational test. The following procedures can be used to isolate the failed component. Suspect the coax switches (N1811-60019), RF cables, or coupler (5087-7754).

NOTE The RF performance of the U3047AM04 depends on the performance of the analyzer. Ensure the analyzer is meeting specification before continuing.

1. Verify that the test set and analyzer's SOURCE, RCVR, CPLR THRU, and CPLR ARM connectors are clean and that the center pins are not damaged.
2. Verify the interface and internal RF cables are cleaned and not damaged. ["Verifying Cal Kit Operational Check Failure"](#) on page 49.
3. Review the ["Cal Kit Operational Check"](#) on page 44 and verify the results for the port that is failing.
4. Reflection tracking trace shows a power hole or is below the test limit line, perform the switch path test for the port that is failing.
5. Isolation is poor between ports, inspect the RF connections. If it continues to fail replace the coax switch (N1811-60019). The RF cables require proper torque (8 in-lb) and can be damaged by over tightening.

Figure 50 Test Set Top View

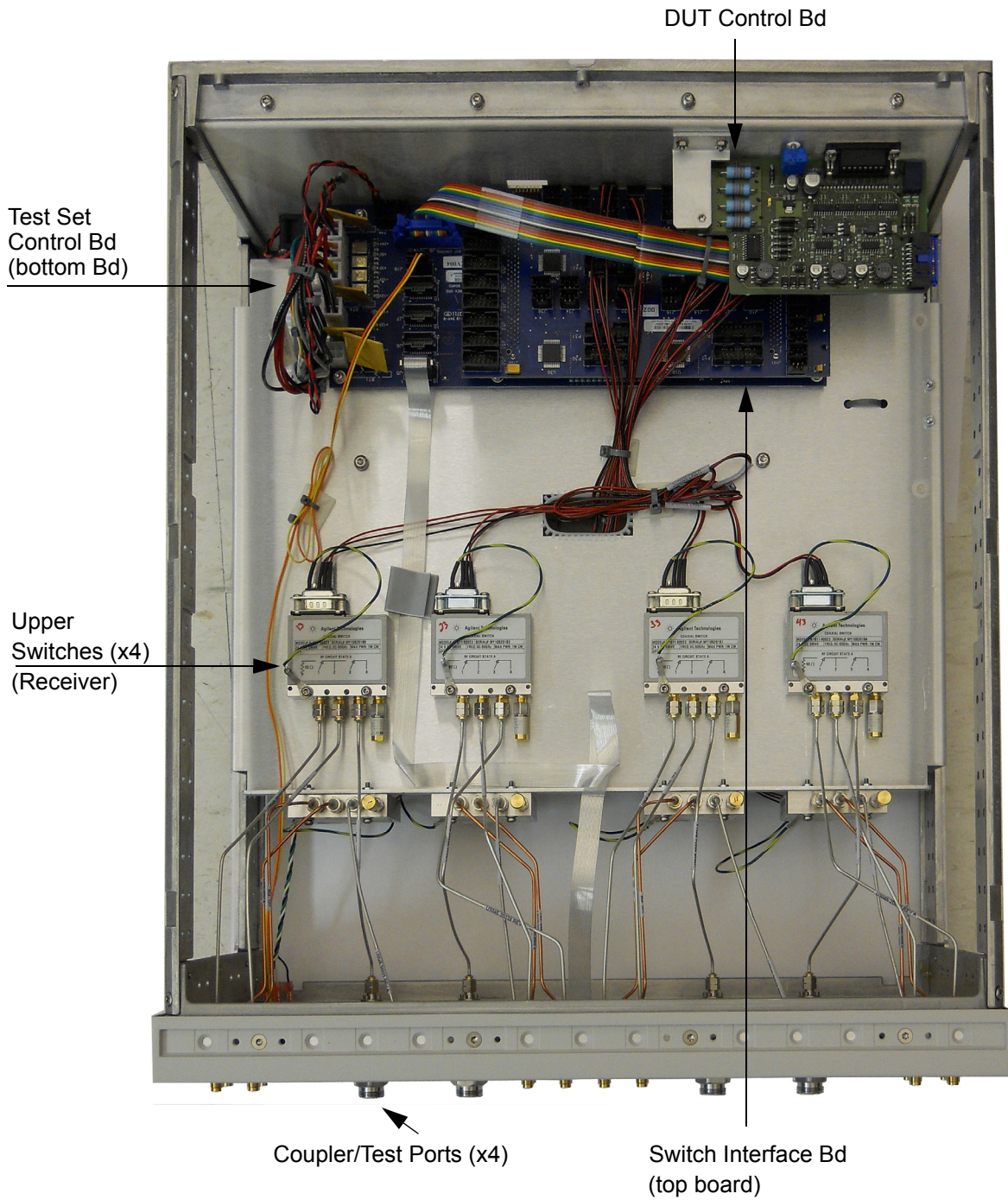
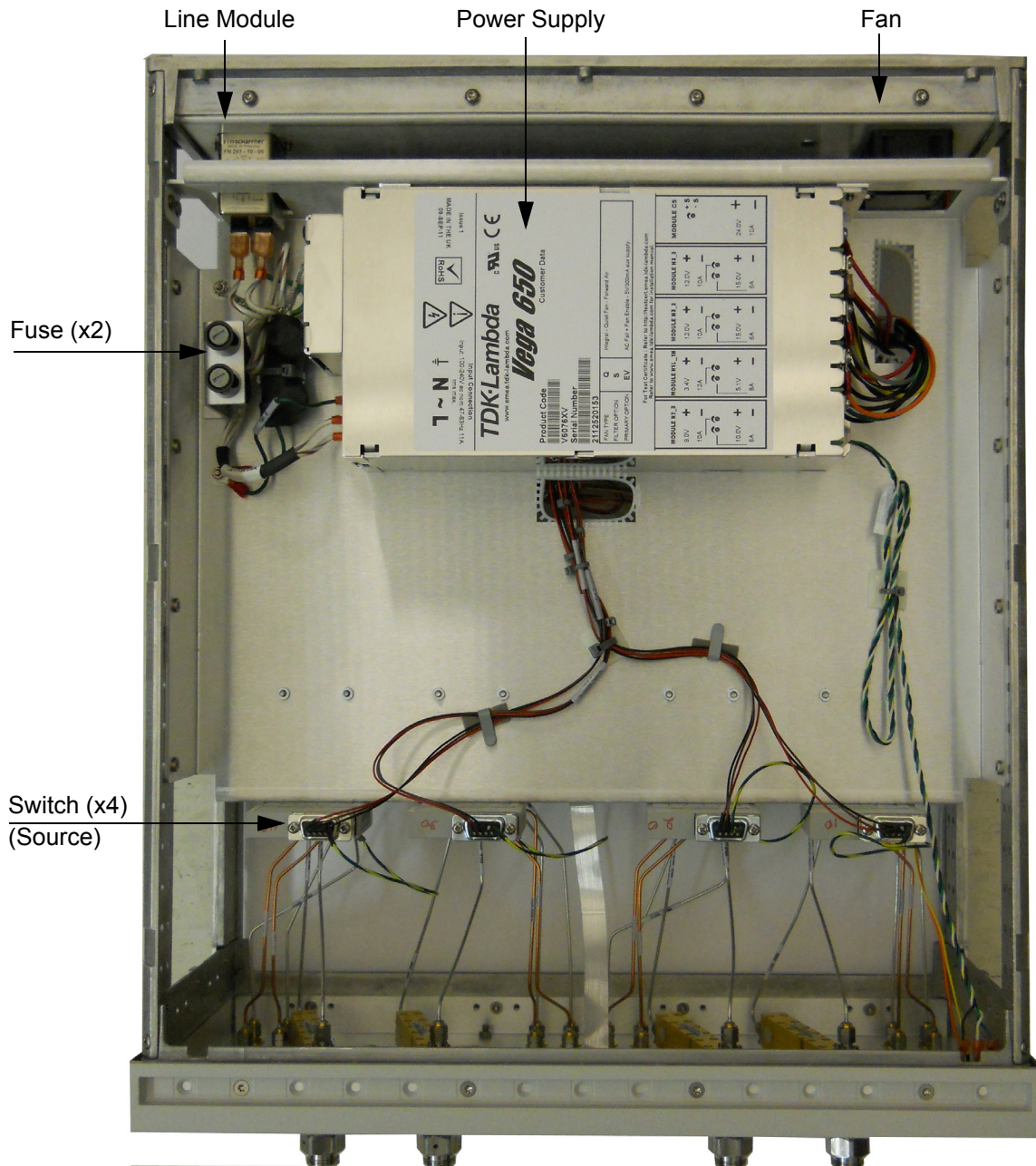

Figure 51 Test Set Bottom View



Safety and Regulatory Information

Introduction

Review this product and related documentation to familiarize yourself with safety markings and instructions before you operate the instrument.

This product has been designed and tested in accordance with accepted industry standards, and has been supplied in a safe condition. The documentation contains information and warnings that must be followed by the user to ensure safe operation and to maintain the product in a safe condition.

Safety Earth Ground

WARNING This is a Safety Class I Product (provided with a protective earthing ground incorporated in the power cord). The mains plug shall be only be inserted in a socket outlet provided with a protective earth contact. Any interruption of the protective conductor inside or outside of the product is likely to make the product dangerous. Intentional interruption is prohibited.

CAUTION Always use the three prong AC power cord supplied with this product. Failure to ensure adequate earth grounding by not using this cord may cause product damage and the risk of electrical shock.

Declaration of Conformity

A copy of the Declaration of Conformity is available upon request, or a copy is available on the Agilent Technologies web site at <http://regulations.corporate.agilent.com/DoC/search.htm>

Statement of Compliance

This product has been designed and tested in accordance with accepted industry standards, and has been supplied in a safe condition. The documentation contains information and warnings that must be followed by the user to ensure safe operation and to maintain the product in a safe condition.

Before Applying Power

Verify that the premises electrical supply is within the range of the instrument. The instrument has an autoranging power supply.

WARNING If this product is not used as specified, the protection provided by the equipment could be impaired. This product must be used in a normal condition (in which all means for protection are intact) only.

CAUTION The Mains wiring and connectors shall be compatible with the connector used in the premise electrical system. Failure, to ensure adequate earth grounding by not using the correct components may cause product damage, and serious injury.

CAUTION This product is designed for use in Installation Category II and Pollution Degree 2.

CAUTION Verify that the premise electrical voltage supply is within the range specified on the instrument.

CAUTION When installing the product in a cabinet, the convection into and out of the product must not be restricted. The ambient temperature (outside the cabinet) must be less than the maximum operating temperature of the product by 4 °C for every 100 watts dissipated in the cabinet. If the total power dissipated in the cabinet is greater than 800 watts, then forced convection must be used.

CAUTION This instrument has auto-ranging line voltage input, be sure the supply voltage is within the specified range and voltage fluctuations do not to exceed 10 percent of the nominal supply voltage.

Servicing

WARNING Danger of explosion if battery is incorrectly replaced. Replace only with the same or equivalent type recommended. Discard used batteries according to manufacturer's instructions.

WARNING These servicing instructions are for use by qualified personnel only. To avoid electrical shock, do not perform any servicing unless you are qualified to do so.

WARNING The opening of covers or removal of parts is likely to expose the user to dangerous voltages. Disconnect the instrument from all voltage sources before opening.

WARNING No operator serviceable parts inside. Refer servicing to qualified personnel. To prevent electrical shock, do not remove covers.

WARNING The detachable power cord is the instrument disconnecting device. It disconnects the mains circuits from the mains supply before other parts of the instrument. The front panel switch is only a standby switch and is not a LINE switch (disconnecting device).

WARNING The power cord is connected to internal capacitors that may remain live for 5 seconds after disconnecting the plug from its power supply.

Connector Care and Cleaning Precautions

Remove the power cord to the instrument. To clean the connectors use alcohol in a well ventilated area. Allow all residual alcohol moisture to evaporate, and fumes to dissipate prior to energizing the instrument.

WARNING To prevent electrical shock, disconnect the [Agilent Technologies U3047AM04](#) from mains electrical supply before cleaning. Use a dry cloth or one slightly dampened with water to clean the external case parts. Do not attempt to clean internally.

WARNING If flammable cleaning materials are used, the material shall not be stored, or left open in the area of the equipment. Adequate ventilation shall be assured to prevent the combustion of fumes, or vapors.

Electrostatic Discharge Protection

Protection against electrostatic discharge (ESD) is essential while removing assemblies from or connecting cables to the instrument. Static electricity can build up on your body and can easily damage sensitive internal circuit elements when discharged. Static discharges too small to be felt can cause permanent damage. To prevent damage to the instrument:

- *always* have a grounded, conductive table mat in front of your test equipment.
- *always* wear a grounded wrist strap with grounding cord, connected to a grounded conductive table mat, having a 1 MW resistor in series with it, when handling components and assemblies or when making connections.
- *always* wear a heel strap (9300-1126) when working in an area with a conductive floor. If you are uncertain about the conductivity of your floor, wear a heel strap.
- *always* ground yourself before you clean, inspect, or make a connection to a static-sensitive device or test port. You can, for example, grasp the grounded outer shell of the test port or cable connector briefly.
- *always* ground the center conductor of a test cable before making a connection to the analyzer test port or other static-sensitive device. This can be done as follows:
 1. Connect a short to one end of the cable to short the center conductor to the outer conductor.
 2. While wearing a grounded wrist strap, grasp the outer shell of the cable connector.
 3. Connect the other end of the cable to the test port and remove the short from the cable.

Figure 52 ESD Protection Setup

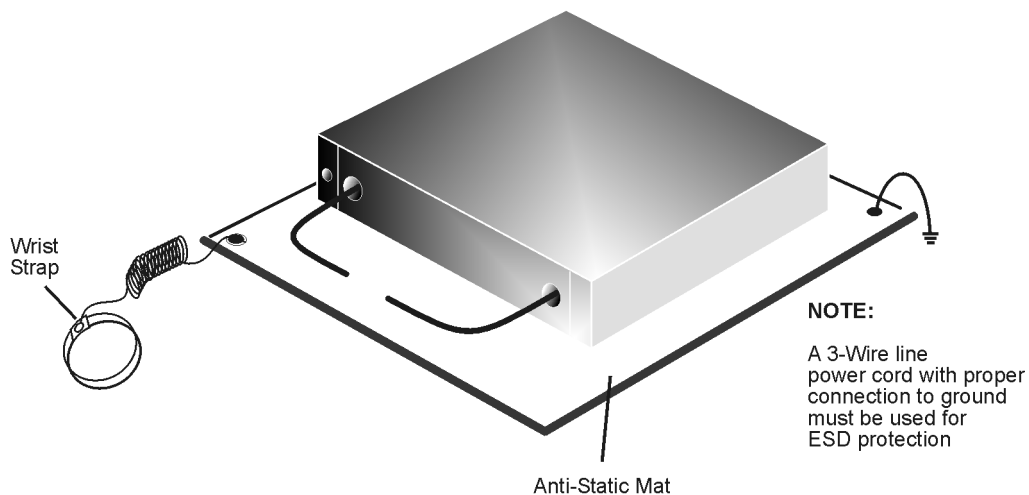

Regulatory Information

Instrument Markings



The instruction documentation symbol. The product is marked with this symbol when it is necessary for the user to refer to the instructions in the documentation.



The AC symbol indicates the required nature of the line module input power.



This symbol indicates separate collection for electrical and electronic equipment, mandated under EU law as of August 13, 2005. All electric and electronic equipment are required to be separated from normal waste for disposal (Reference WEEE Directive, 2002/96/EC).



This symbol indicates that the power line switch is ON.



This symbol indicates that the power line switch is in the STANDBY position.



This symbol indicates that the power line switch is in the OFF position.



This symbol is used to identify a terminal which is internally connected to the product frame or chassis.



The CE mark is a registered trademark of the European Community. (If accompanied by a year, it is when the design was proven.)



The CSA mark is a registered trademark of the CSA International. This instrument complies with Canada: CSA 22.2 No. 61010-1-04.



This is a symbol of an Industrial Scientific and Medical Group 1 Class A product (CISPR 11, Clause 54)



This is a marking to indicate product compliance with the Canadian Interference-Causing Equipment Standard (ICES-001).



Direct Current.



The instrument has been designed to meet the requirements of IP 2 0 for ingress and operational environment.



This is a required mark signifying compliance with an EMC requirement. The C-Tick mark is a registered trademark of the Australian Spectrum Management Agency.



Indicates the time period during which no hazardous or toxic substance elements are expected to leak or deteriorate during normal use. Forty years is the expected useful life of the product.



This symbol on all primary and secondary packaging indicates compliance to China standard GB 18455-2001.



South Korean Certification (KC) mark; includes the marking's identifier code which follows this format: MSIP-REM-YYY-ZZZZZZZZZZZZZZ.

Battery Collection

Do not throw batteries away but collect as small chemical waste, or in accordance with your country's requirements. You may return the battery to Agilent Technologies for disposal. Refer to [“Contacting Agilent” on page 74](#) for assistance.

Electrical Safety Compliance

SAFETY

Complies with European Low Voltage Directive 2006/95/EC

- IEC/EN 61010-1, 2nd Edition
- Canada: CSA C22.2 No. 61010-1-04
- USA: UL std no. 61010-1, 2nd Edition
- Acoustic statement (European Machinery Directive 2022/42/EC, 1.7.4.2U)
 Accoustical noise emission
 LpA<70 dB
 Operator position
 Normal operation mode
 Per ISO 7779

EMI and EMC Compliance

EMC

Complies with European EMC Directive 2004/108/EC

- IEC/EN 61326-1
- CISPR Pub 11 Group 1, class A
- AS/NZS CISPR 11
- ICES/NMB-001
 This ISM device complies with Canadian ICES-001.
 Cet appareil ISM est conforme a la norme NMB du Canada.
- South Korean Class A EMC declaration: This equipment is Class A suitable for professional use and is for use in electromagnetic environments outside of the home.

A 급 기기 (업무용 방송통신기자재) 이 기기는 업무용 (A 급) 전자파적합기기로서 판매자 또는 사용자는 이 점을 주의하시기 바라 며 , 가정외의 지역에서 사용하는 것을 목적으로 합니다 .

Agilent Support, Services, and Assistance

Service and Support Options

There are many other repair and calibration options available from the Agilent Technologies support organization. These options cover a range of service agreements with varying response times. Contact Agilent for additional information on available service agreements for this product.

Contacting Agilent

Assistance with test and measurements needs and information or finding a local Agilent office are available on the Web at: <http://www.agilent.com/find/assist>

If you do not have access to the Internet, contact your field engineer.

NOTE In any correspondence or telephone conversation, refer to the Agilent product by its model number and full serial number. With this information, the Agilent representative can determine the warranty status of your unit.

Shipping Your Product to Agilent for Service or Repair

IMPORTANT Agilent Technologies reserves the right to reformat or replace the internal hard disk drive in your analyzer as part of its repair. This will erase all user information stored on the hard disk. It is imperative, therefore, that you make a backup copy of your critical test data located on the analyzer's hard disk before shipping it to Agilent for repair.

If you wish to send your instrument to Agilent Technologies for service or repair:

- To improve turn-around time, return your test set along with your analyzer and cables to Agilent so that we may verify the operation of the complete system.
- Include a complete description of the service requested or of the failure and a description of any failed test and any error message.
- Remove and retain the front handles and all rack mount hardware. The analyzer should be sent to Agilent in the same configuration as it was originally shipped.
- Ship the analyzer using the original or comparable antistatic packaging materials.
- Contact Agilent for instructions on where to ship your analyzer.